

GUIDA ALL' ACQUISTO

Divisione bagno

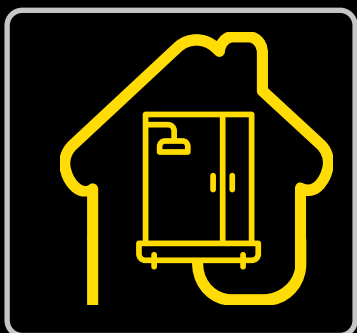

MagicFlex



Box & piatti doccia
Sistemi di scarico
Complementi doccia

Prodotti, soluzioni
& accessori

FERRARI

www.ferrariwelcome.it





Inquadra i QR code presenti in alcune pagine di questo catalogo per avere maggiori informazioni sul prodotto, schede tecniche, video esplicativi e tanto altro!



Inquadra questo QR code per essere sempre aggiornato sulle modifiche tecniche, errata corrige, novità prodotti, ecc.



Ferrari s.r.l. dichiara che i prodotti qui inseriti sono realizzati a regola d'arte e, dove richiesto, sono certificati per l'idoneità di utilizzo secondo le norme vigenti. I prodotti nel presente catalogo sono da intendersi ad esclusivo uso professionale e destinati a soggetti in possesso della professionalità richiesta per il tipo di prodotto, con espressa esclusione dei consumatori. La buona rispondenza dei materiali agli usi espressamente indicati è condizionata alla corretta installazione oltre che al corretto dimensionamento ed utilizzo degli accessori previsto dalle norme. La nostra responsabilità è limitata alla qualità dei materiali; le illustrazioni, le foto, le misure e quant'altro indicato non sono impegnative e possono variare senza alcun obbligo di preavviso.



Sono la **passione** e la **curiosità** a guidare l'innovazione.
Se non si ha **passione**, non si ha **energia**.

Questi principi sono gli elementi che caratterizzano, da oltre 60 anni, tutto il nostro team composto da molti collaboratori di "lungo corso" e da giovani risorse che creano il giusto mix ricco di esperienza e professionalità proiettato verso il futuro portandoci a sviluppare servizi, proposte e soluzioni al passo con i tempi.

La **passione** è l'elemento trainante, una continua evoluzione e ricerca dedicata a supportare i continui cambiamenti del nostro mercato, un confronto costruttivo e continuo con tutti i nostri clienti, partner e collaboratori.

La **curiosità** ci porta ad esplorare nuovi settori, consentendoci di accrescere le nostre competenze permettendoci di offrire prodotti innovativi che soddisfano e anticipano le esigenze del mercato.

La nuova proposta di cataloghi specifici che presentiamo segna un passo in avanti nella crescita della Ferrari; una leva importante che, attraverso una più profonda focalizzazione delle gamme di prodotti, vuole fidelizzare e supportare gli attuali clienti e collaboratori sviluppando nuove partnership.

Buona consultazione!



Linea LOFTY

quando sono i dettagli a fare la differenza

La funzionalità è il cuore di ogni ambiente domestico ma soprattutto del tuo bagno.
 Se unita allo stile, il risultato è un arredo pensato per ogni necessità che non rinuncia a qualità ed estetica.
 Da qui nasce la linea di box doccia LOFTY: essenziale nelle sue finiture, pratica e curata in ogni minimo dettaglio.

VANTAGGI

FACILE DA MONTARE

**CHIUSURA MAGNETICA
SILENZIATA**

**AMPIA GAMMA
DI MISURE**

REVERSIBILE

ESTENSIBILE

SGANCIO RAPIDO

ANTIBATTERICO

ANTIMUFFA

Profilo coprifissaggi



Particolare copertura



Particolare maniglia



Particolare porta soffietto



Caratteristiche

| | |
|-----------|---|
| Altezza | 200 cm |
| Cristallo | Trasparente spessore 6mm (8 mm Walk-in) Norma EN12150 -1 |
| Profili | Alluminio cromato lucido con coprifissaggio |
| Maniglie | Cromate |



TIPOLOGIE DISPONIBILI:



Lato per angolo con apertura scorrevole laterale



Porta a due ante con apertura scorrevole laterale



Porta a tre ante con apertura scorrevole laterale



Porta battente pivot



Porta a soffietto con apertura interna (esterna antipanico)



Parete laterale



Parete doccia Walk-in

POSSIBILI COMBINAZIONI:
ANGOLO

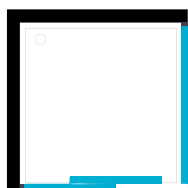

2 x LATO
SCORREVOLE
A DUE ANTE



1 x LATO FISSO
+
1 x PORTA
SCORREVOLE
A DUE ANTE

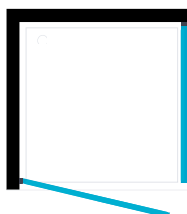

1 x LATO FISSO
+
1 x PORTA
SCORREVOLE
A TRE ANTE



1 x LATO FISSO
+
1 x PORTA
A BATTENTE



1 x LATO FISSO
+
1 x PORTA
A SOFFIETTO

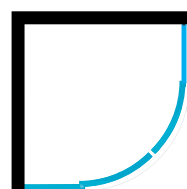

1 x ANGOLARE
SEMICIRCOLARE

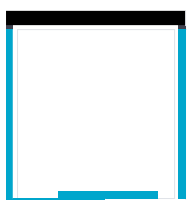
CENTRO PARETE

2 x LATO FISSO
+
1 x PORTA
SCORREVOLE
A DUE ANTE

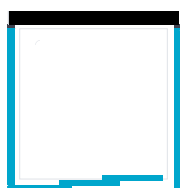

2 x LATO FISSO
+
1 x PORTA
SCORREVOLE
A TRE ANTE

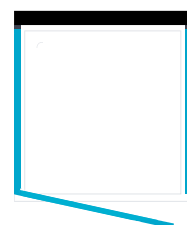

2 x LATO FISSO
+
1 x PORTA
A BATTENTE



2 x LATO FISSO
+
1 x PORTA
A SOFFIETTO



1 x LATO FISSO
+
2 x LATO
SCORREVOLE
A DUE ANTE

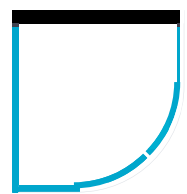

1 x LATO FISSO
+
1 x ANGOLARE
SEMICIRCOLARE

NICCHIA

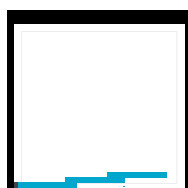

1 x PORTA
SCORREVOLE
A DUE ANTE

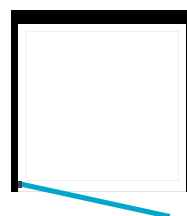

1 x PORTA
SCORREVOLE
A TRE ANTE

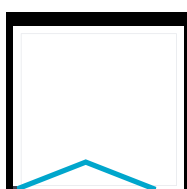

1 x PORTA
A BATTENTE

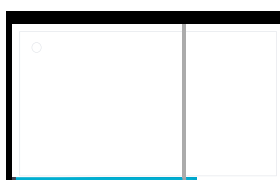

1 x PORTA
A SOFFIETTO

WALK-IN

1 x WALK-IN
CON BRACCIO

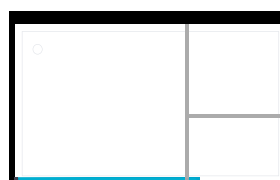

2 x WALK-IN
CON 1 BRACCIO A T



Linea LOFTY

LATO PER ANGOLO
APERTURA SCORREVOLE LATERALE



| CODICE | EURO/PZ | VERSIONE | | PZ |
|--------|---------|----------|---------------------|----|
| | | L cm | Estensibilità cm | |
| 601630 | | 65 | 63 ÷ 65 | 1 |
| 601631 | | 70 | 68 ÷ 70 | 1 |
| 601632 | | 75 | 73 ÷ 75 | 1 |
| 601633 | | 80 | 78 ÷ 80 | 1 |
| 601634 | | 90 | 88 ÷ 90 | 1 |
| 601635 | | 100 | 98 ÷ 100 | 1 |
| 601636 | | 110 | 108 ÷ 110 | 1 |
| 601637 | | 120 | 118 ÷ 120 | 1 |
| 601638 | | 130 | 128 ÷ 130 | 1 |
| 601639 | | 140 | 138 ÷ 140 | 1 |



Esempio con 2 lati
angolari

Linea LOFTY

PORTA A DUE ANTE
CON APERTURA SCORREVOLE LATERALE

BOX DOCCIA

Linea LOFTY

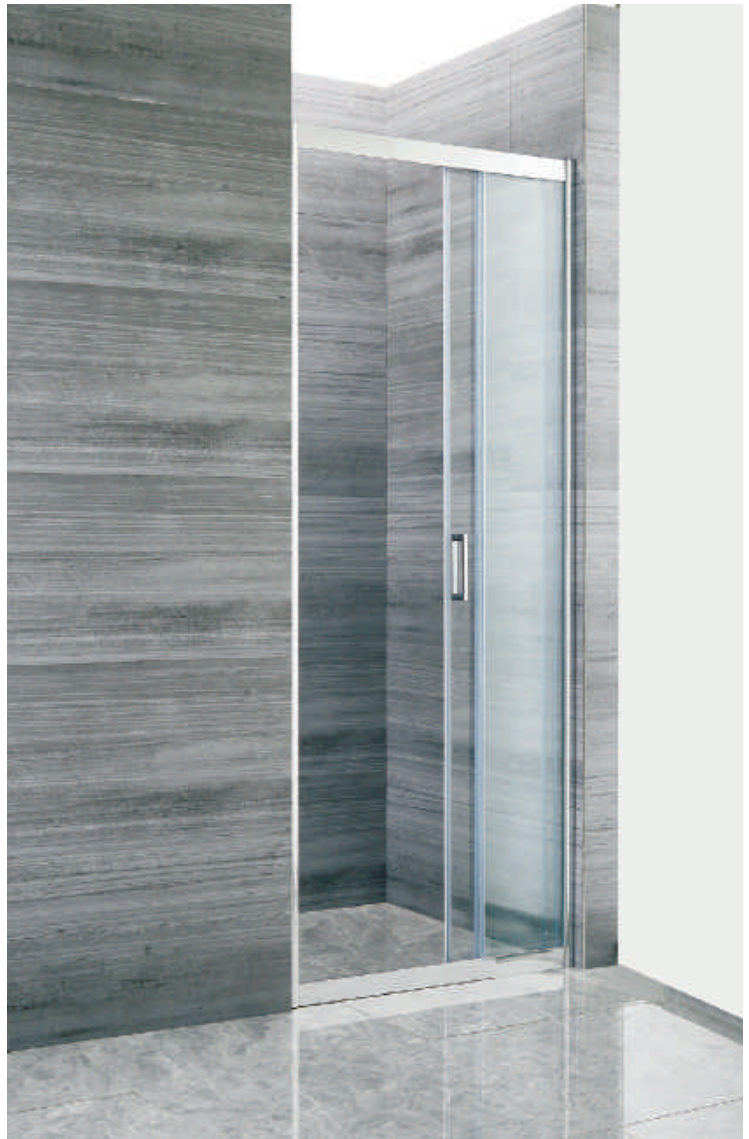

Esempio con parete
laterale

| CODICE | EURO/PZ | VERSIONE | | | PZ |
|--------|---------|----------|---------------------|----------------|----|
| | | L cm | Estensibilità cm | Ingresso cm | |
| 601640 | | 100 | 96 ÷ 100 | 42 | 1 |
| 601641 | | 110 | 106 ÷ 110 | 46 | 1 |
| 601642 | | 120 | 116 ÷ 120 | 51 | 1 |
| 601664 | | 130 | 126 ÷ 130 | 56 | 1 |
| 601643 | | 140 | 136 ÷ 140 | 60 | 1 |
| 601663 | | 150 | 146 ÷ 150 | 65 | 1 |
| 601644 | | 160 | 156 ÷ 160 | 70 | 1 |
| 601645 | | 170 | 166 ÷ 170 | 75 | 1 |



Linea LOFTY

PORTA SCORREVOLE A TRE ANTE
CON APERTURA SCORREVOLE LATERALE

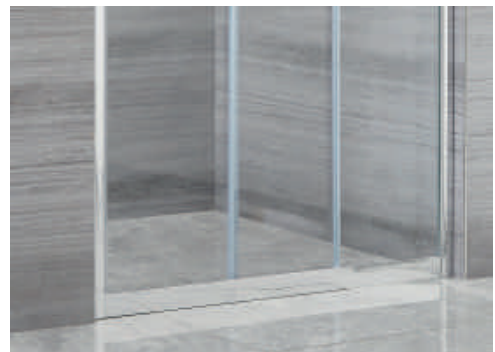

Esempio con parete laterale

| CODICE | EURO/PZ | VERSIONE | | | PZ |
|--------|---------|----------|---------------------|----------------|----|
| | | L cm | Estensibilità cm | Ingresso cm | |
| 601646 | | 100 | 96 ÷ 100 | 52 | 1 |
| 601647 | | 110 | 106 ÷ 110 | 58 | 1 |
| 601648 | | 120 | 116 ÷ 120 | 65 | 1 |

Linea LOFTY

PORTA BATTENTE PIVOT

Linea LOFTY

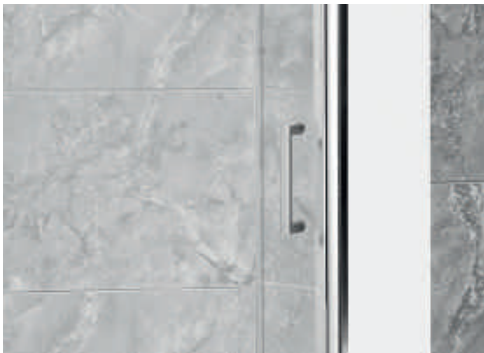

| CODICE | EURO/PZ | VERSIONE | | | PZ |
|--------|---------|----------|---------------------|----------------|----|
| | | L cm | Estensibilità cm | Ingresso cm | |
| 601649 | | 70 | 66 ÷ 70 | 58 | 1 |
| 601650 | | 75 | 71 ÷ 75 | 63 | 1 |
| 601651 | | 80 | 76 ÷ 80 | 68 | 1 |
| 601652 | | 90 | 86 ÷ 90 | 78 | 1 |



Linea LOFTY

PORTA A SOFFIETTO
CON APERTURA INTERNO/ESTERNO (ANTIPANICO)



Esempio apertura esterna
(antipanico)

| CODICE | EURO/PZ | VERSIONE | | | PZ |
|--------|---------|----------|---------------------|----------------|----|
| | | L cm | Estensibilità cm | Ingresso cm | |
| 601653 | | 70 | 66 ÷ 70 | 42 | 1 |
| 601654 | | 75 | 71 ÷ 75 | 46 | 1 |
| 601655 | | 80 | 76 ÷ 80 | 49,5 | 1 |
| 601656 | | 90 | 86 ÷ 90 | 57 | 1 |
| 601665 | | 100 | 96 ÷ 100 | 65 | 1 |

Linea LOFTY



BOX DOCCIA

Linea LOFTY

**ANGOLARE SEMICIRCOLARE
CON APERTURA CENTRALE (R. 55 CM)**

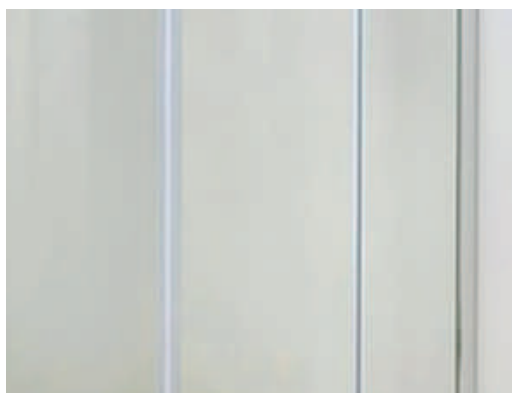
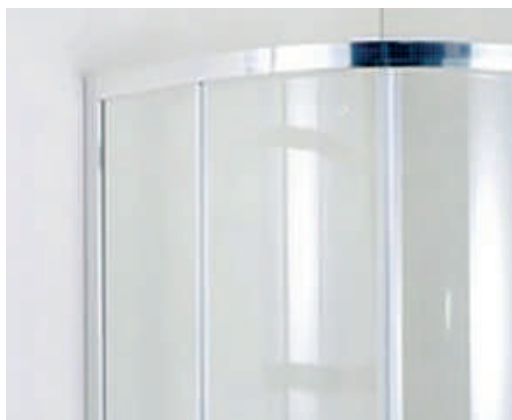

Apertura centrale

| CODICE | EURO/PZ | VERSIONE | | | PZ |
|--------|---------|----------|---------------------|----------------|----|
| | | L cm | Estensibilità cm | Ingresso cm | |
| 601657 | | 80x80 | 78 ÷ 80 x 78 ÷ 80 | 46 | 1 |
| 601658 | | 90x90 | 88 ÷ 90 x 88 ÷ 90 | 52 | 1 |



Linea LOFTY

PARETE LATERALE



| CODICE | EURO/PZ | VERSIONE | | PZ |
|--------|---------|----------|---------------------|----|
| | | L cm | Estensibilità cm | |
| 601659 | | 70 | 68 ÷ 70 | 1 |
| 601660 | | 75 | 73 ÷ 75 | 1 |
| 601661 | | 80 | 78 ÷ 80 | 1 |
| 601662 | | 90 | 88 ÷ 90 | 1 |



Linea LOFTY

PARETE DOCCIA WALK IN

Spessore cristallo: **8 mm**, incluso braccetto stabilizzatore telescopico in ottone cromato da 80 a 120 cm.

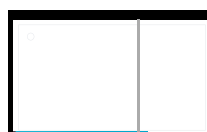
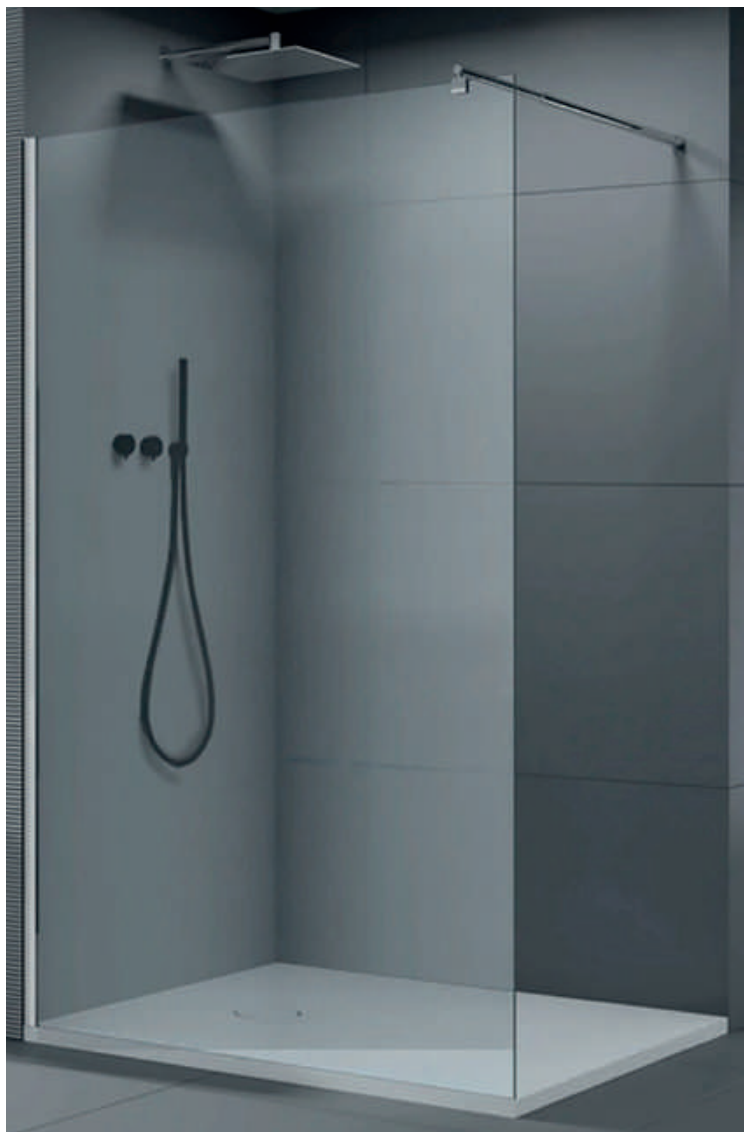
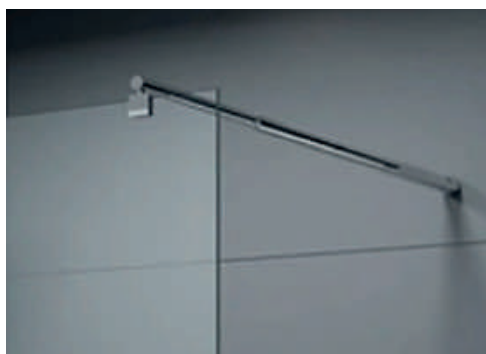
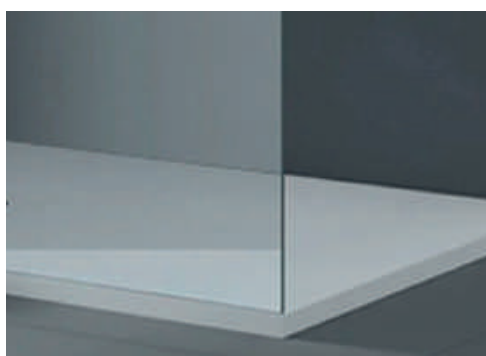

Esempio WALK-IN 1 lato con 1 braccio

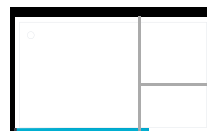

Esempio WALK-IN 2 lati con 2 bracci e raccordo

| CODICE | EURO/PZ | VERSIONE | | PZ |
|--------|---------|----------|------------------|----|
| | | L cm | Estensibilità cm | |
| 601097 | | 70 | 67 ÷ 69 | 1 |
| 601099 | | 80 | 77 ÷ 79 | 1 |
| 601101 | | 90 | 87 ÷ 89 | 1 |
| 601103 | | 100 | 97 ÷ 99 | 1 |
| 601105 | | 110 | 107 ÷ 109 | 1 |
| 601107 | | 120 | 117 ÷ 119 | 1 |
| 601109 | | 140 | 137 ÷ 139 | 1 |
| 601111 | | 150 | 147 ÷ 149 | 1 |
| 601113 | | 160 | 157 ÷ 159 | 1 |

RACCORDO PER DUE PARETI DOCCIA WALK - IN

| CODICE | EURO/PZ | PZ |
|--------|---------|----|
| 601710 | | 1 |



COPPIA DI CUSCINETTI SCORREVOLI

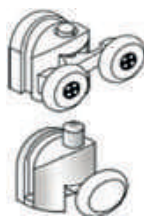

Coppia di cuscinetti scorrevoli uno superiore e uno inferiore.
Per modelli:
 angolo - semicircolare - porta scorrevole

| CODICE | EURO/CONF. | PZ. |
|--------|------------|-----|
| 601695 | | 1 |

PROFILO DI COMPENSAZIONE

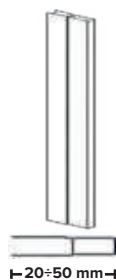

Per modelli:
 angolo - semicircolare - porta scorrevole - porta pivot scorrevole a tre ante
 porta a soffietto - parete laterale

| CODICE | EURO/PZ | PZ. |
|--------|---------|-----|
| 601690 | | 1 |

PROFILO MURO

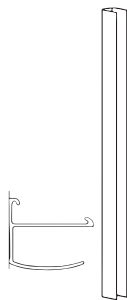

Per modelli:
 angolo - semicircolare - porta scorrevole - porta pivot scorrevole a tre ante
 porta a soffietto - parete laterale

| CODICE | EURO/PZ | PZ. |
|--------|---------|-----|
| 601708 | | 1 |

PROFILO COPRIFISSAGGI



Per modelli:
 angolo - semicircolare - porta scorrevole - porta pivot scorrevole a tre ante
 porta a soffietto - parete laterale

| CODICE | EURO/PZ | PZ. |
|--------|---------|-----|
| 601691 | | 1 |

KIT DI GIUNZIONE ANGOLARE

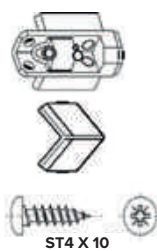

Per modelli: angolo

| CODICE | EURO/PZ | PZ. |
|--------|---------|-----|
| 601707 | | 1 |

KIT DI FISSAGGIO PROFILO A MURO

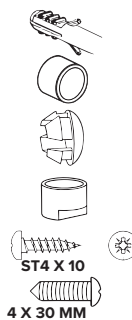

Per modelli:
 angolo - semicircolare - porta scorrevole - porta pivot scorrevole a tre ante
 porta a soffietto - parete laterale

| CODICE | EURO/PZ | PZ. |
|--------|---------|-----|
| 601692 | | 1 |

MANIGLIA COMPLETA PER PORTA
 parte interna ed esterna



Per modelli:
 angolo - semicircolare - porta scorrevole - porta pivot scorrevole a tre ante
 porta a soffietto - parete laterale

| CODICE | EURO/PZ | PZ. |
|--------|---------|-----|
| 601711 | | 1 |

KIT FERMAPORTA

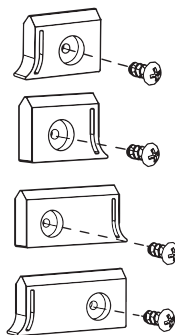

Per modelli:
 angolo - semicircolare - porta scorrevole

| CODICE | EURO/PZ | PZ. |
|--------|---------|-----|
| 601705 | | 1 |

COPERCHI PER PROFILI VERTICALI PER MONTANTE

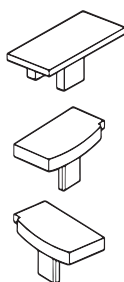

Per modelli:
 angolo - semicircolare - porta scorrevole - porta pivot scorrevole a tre ante

| CODICE | EURO/PZ | PZ. |
|--------|---------|-----|
| 601694 | | 1 |

COPERCHI PER PROFILI VERTICALI PER MONTANTE

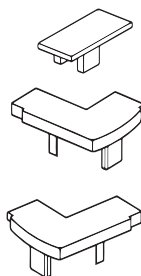

Per modello:
 parete fissa

| CODICE | EURO/PZ | PZ. |
|--------|---------|-----|
| 601693 | | 1 |

**GUARNIZIONE A BAFFO ESTERNO 1 X BOX
(L. 1820 MM)**

Per modelli:
angolo - semicircolare
porta scorrevole

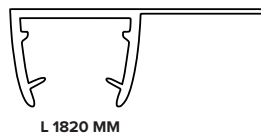

| CODICE | EURO/PZ | PZ. |
|--------|---------|-----|
| 601703 | | 1 |

**GUARNIZIONE A BAFFO INTERNO 1 X BOX
(L. 1880 MM)**

Per modelli:
angolo - semicircolare
porta scorrevole

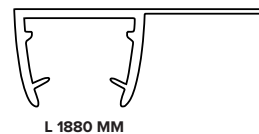

| CODICE | EURO/PZ | PZ. |
|--------|---------|-----|
| 601702 | | 1 |

GUARNIZIONE A PALLONCINO 1 X BOX

Per modelli:
angolo - semicircolare
porta scorrevole

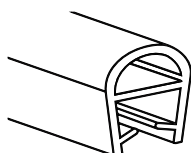

| CODICE | EURO/PZ | PZ. |
|--------|---------|-----|
| 601699 | | 1 |

**GUARNIZIONE MAGNETICA 1 X BOX
2 PEZZI**

Per modello:
semicircolare



| CODICE | EURO/PZ | PZ. |
|--------|---------|-----|
| 601698 | | 1 |

**GUARNIZIONE MAGNETICA AD ANGOLO
1 X BOX**

Per modello: angolo

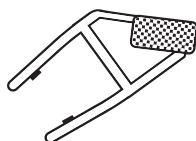

| CODICE | EURO/PZ | PZ. |
|--------|---------|-----|
| 601697 | | 1 |

**GUARNIZIONE VERTICALE PER PORTA PIVOT
1 X BOX**

Per modello:
porta pivot



| CODICE | EURO/PZ | PZ. |
|--------|---------|-----|
| 601701 | | 1 |

**GUARNIZIONE MAGNETICA PER PORTA PIVOT
1 X BOX**

Per modello:
porta pivot



| CODICE | EURO/PZ | PZ. |
|--------|---------|-----|
| 601700 | | 1 |

**GUARNIZIONE INFERIORE PER PORTA PIVOT
1 X BOX**

Per modello:
porta pivot

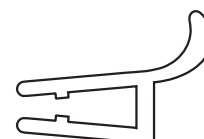

| CODICE | EURO/PZ | PZ. |
|--------|---------|-----|
| 601696 | | 1 |

**GUARNIZIONE MAGNETICA PER SCORREVOLE
1 X BOX**

Per modello:
porta scorrevole

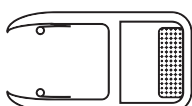

| CODICE | EURO/PZ | PZ. |
|--------|---------|-----|
| 601704 | | 1 |

**KIT DI FISSAGGIO PER PROFILO
DI COMPENSAZIONE**

Per modelli:
angolo - semicircolare
porta scorrevole - porta pivot
scorrevole a tre ante
porta a soffietto - parete laterale

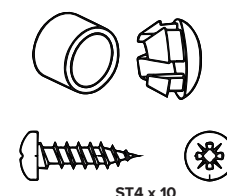

| CODICE | EURO/PZ | PZ. |
|--------|---------|-----|
| 601706 | | 1 |



Linea ACRIL

ESTENSIBILE - REVERSIBILE - RIDUCIBILE

ANGOLO DOCCIA CON APERTURA SCORREVOLE LATERALE



Caratteristiche

| | |
|----------|---------------------|
| Altezza | 190 cm |
| Pannello | spessore 1,8 mm |
| Profili | PVC bianco pastello |
| Chiusure | magnetiche |



| CODICE | EURO/PZ | VERSIONE | | PZ |
|--------|---------|------------------|----------------|----|
| | | Dimensioni cm | Ingresso cm | |
| 601800 | | 70÷65 x 70÷65 | 38 | 1 |
| 601801 | | 70÷65 x 90÷85 | 46 | 1 |
| 601802 | | 70÷65 x 100÷105 | 50 | 1 |
| 601803 | | 70÷65 x 120÷115 | 58 | 1 |
| 601804 | | 75÷70 x 75÷70 | 42 | 1 |
| 601805 | | 75÷70 x 90÷85 | 47 | 1 |
| 601806 | | 80÷75 x 80÷75 | 45 | 1 |
| 601807 | | 80÷75 x 100÷95 | 53 | 1 |
| 601808 | | 80÷75 x 120÷115 | 61 | 1 |
| 601809 | | 90÷85 x 90÷85 | 52 | 1 |
| 601810 | | 100÷75 x 100÷95 | 59 | 1 |



Linea ACRIL

ESTENSIBILE - REVERSIBILE - RIDUCIBILE

PORTA SCORREVOLE A DUE ANTE PER NICCHIA CON APERTURA SCORREVOLE LATERALE

Caratteristiche

| | |
|----------|---------------------|
| Altezza | 190 cm |
| Pannello | spessore 1,8 mm |
| Profili | PVC bianco pastello |
| Chiusure | magnetiche |

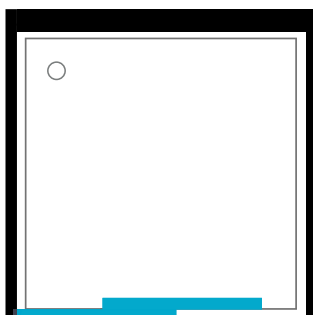
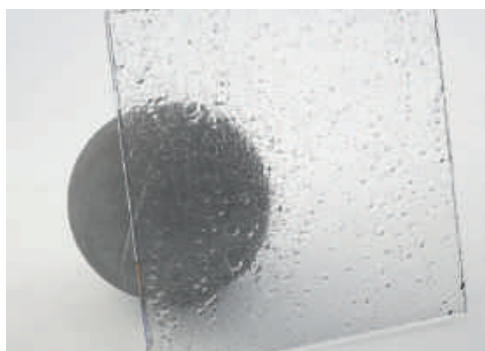

| CODICE | EURO/PZ | VERSIONE | | PZ |
|--------|---------|------------------|----------------|----|
| | | Dimensioni cm | Ingresso cm | |
| 601815 | | 100÷90 | 42 | 1 |
| 601816 | | 110÷100 | 47 | 1 |
| 601817 | | 120÷110 | 52 | 1 |
| 601818 | | 130÷120 | 57 | 1 |
| 601819 | | 140÷130 | 62 | 1 |
| 601820 | | 150÷140 | 66 | 1 |



Linea ACRIL

ESTENSIBILE - REVERSIBILE - RIDUCIBILE

PARETE LATERALE



Caratteristiche

| | |
|----------|---------------------|
| Altezza | 190 cm |
| Pannello | spessore 1,8 mm |
| Profili | PVC bianco pastello |
| Chiusure | magnetiche |

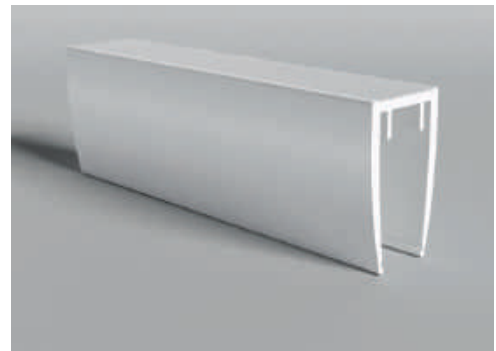

| CODICE | EURO/PZ | VERSIONE Dimensioni cm | PZ |
|--------|---------|------------------------------|----|
| 601825 | | 67÷70 | 1 |
| 601826 | | 72÷75 | 1 |
| 601827 | | 77÷80 | 1 |
| 601828 | | 87÷90 | 1 |

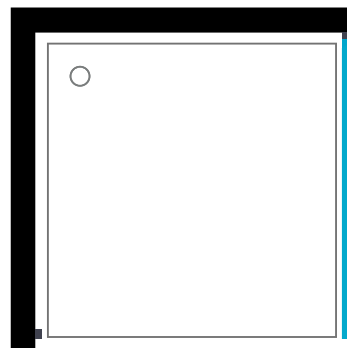

Linea ACRIL

ESTENSIBILE - REVERSIBILE - RIDUCIBILE

ANGOLARE DOCCIA SEMICIRCOLARE CON APERTURA CENTRALE (R. 55 CM)

Caratteristiche

| | |
|----------|---------------------|
| Altezza | 190 cm |
| Pannello | spessore 2,2 mm |
| Profili | PVC bianco pastello |
| Chiusure | magnetiche |

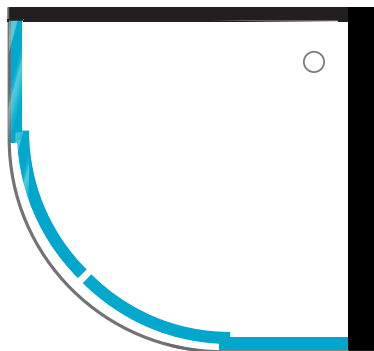

| CODICE | EURO/PZ | VERSIONE | | PZ |
|--------|---------|------------------|----------------|----|
| | | Dimensioni cm | Ingresso cm | |
| 601835 | | 80÷75 x 80÷75 | 48 | 1 |
| 601836 | | 90÷85 x 90÷85 | 55 | 1 |
| 601837 | | 100÷95 x 100÷95 | 62 | 1 |



PIATTO DOCCIA

ZERO Mineral Plane

Design, stile e funzionalità si incontrano per dar vita a questa collezione unica e moderna

I piatti doccia **extra piani ZERO** sono fabbricati con una base strutturale, realizzata con una carica minerale ottenuta dalla miscelazione di Dolomia e Silice tixotropica e resina poliesteri isoftalica. Tale base strutturale viene ricoperta con un particolare e spesso strato di gel coat di resina poliesteri ISO NPG lavorata con una particolare tecnologia implementata direttamente dal produttore. La particolare composizione della carica minerale della struttura, **priva di carbonato di calcio**, garantisce uniformità, stabilità dimensionale, forte resistenza alle sollecitazioni meccaniche, termiche e alla corrosione. Il rivestimento del particolare geal coat ISO NPG inoltre garantisce una grande resistenza all'usura e agli urti accidentali e una Classe 3 antiscivolo.

Disponibili in 4 colori standard e 47 misure.
Texture : ardesia

VANTAGGI

| | | | | |
|---------------------------------|--------------------------------|--------------------------------------|--------------------------------|--|
| ANTISCIVOLO CLASSE 3 | RESISTE AI RAGGI UV | BORDI RIFINITI TAGLIABILI | 35% DI PESO RIDOTTO | FACILE DA PULIRE ESENTE DA IDROLISI |
| ANTIBATTERICO | RIPARABILE | ELEVATA DUREZZA | TAGLIABILE | |

Caratteristiche

| | |
|-----------------------------|--|
| Materiale | resina e carica minerale e miscela oftalmica |
| Copertura | gel coat spessore 2,5÷2,7 mm |
| Antiscivolo | UNE ENV 12633 - Classe 3 |
| Idoneità pulizia e durata | UNE EN 14527 - Class 1 |
| Durezza Barcol | 4,5 |
| Soglia tolleranza curvatura | 0,3% |
| Scarico sifone | orizzontale c/fissaggio a ghiera a tre viti |
| Capacità di scarico sifone | 58 litri/min |
| Griglia | inossidabile - in tinta con il piatto |

DIMENSIONI PIATTO

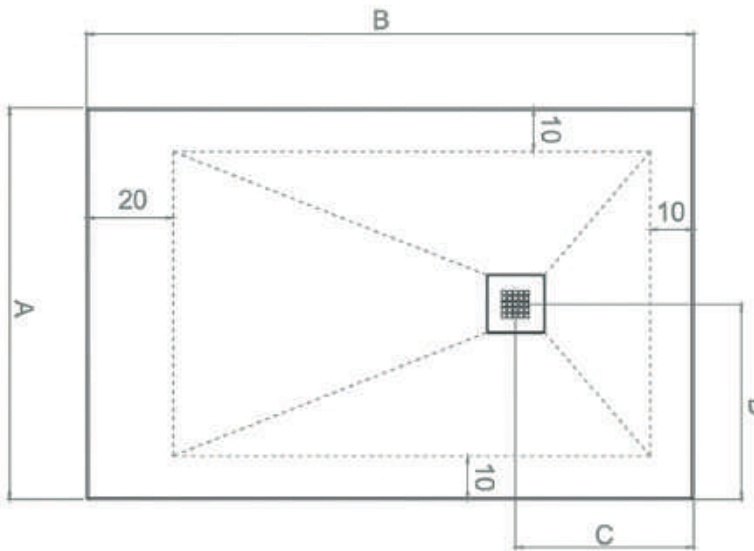

| | A | B | C | D |
|-----|--|-----------------|-----|------|
| 70 | 90 / 100 / 120 / 130 / 140 / 150 / 160 | 170 / 180 / 200 | 41 | 35 |
| | | | 61 | |
| 75 | 100 / 120 / 130 / 140 / 150 / 160 | 170 / 180 | 41 | 37,5 |
| | | | 61 | |
| 80 | 90 / 100 / 120 / 130 / 140 / 150 / 160 | 170 / 180 / 200 | 80 | 40 |
| | | | 40 | |
| 90 | 120 / 140 | 180/200 | 90 | 45 |
| | | | 100 | |
| | | | 45 | |
| | | | 41 | |
| 100 | 160/180/200 | 215 | 61 | 50 |
| | | | 50 | |
| | | | 45 | |
| 110 | 200 | | 77 | 57,5 |
| | | | 61 | |

(Quote in cm)

2'5 - 2,7 cm



DIMENSIONI SIFONE



VALVOLA INCLUSA
58 litri/min

**GRIGLIA IN TINTA CON IL PIATTO
INCLUSA**

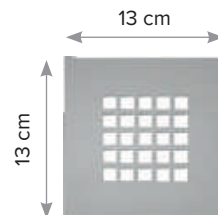

FINITURE





Piatto doccia ZERO - 700 mm

| CODICE | EURO/PZ | VERSIONE | | PZ |
|--------|---------|---------------|-----------|----|
| | | Dimensioni mm | Finitura | |
| 602000 | | 700 x 900 | bianco | 1 |
| 602001 | | | cemento | 1 |
| 602002 | | | antracite | 1 |
| 602003 | | | corda | 1 |

| CODICE | EURO/PZ | VERSIONE | | PZ |
|--------|---------|---------------|-----------|----|
| | | Dimensioni mm | Finitura | |
| 602005 | | 700 x 1000 | bianco | 1 |
| 602006 | | | cemento | 1 |
| 602007 | | | antracite | 1 |
| 602008 | | | corda | 1 |

| CODICE | EURO/PZ | VERSIONE | | PZ |
|--------|---------|---------------|-----------|----|
| | | Dimensioni mm | Finitura | |
| 602015 | | 700 x 1200 | bianco | 1 |
| 602016 | | | cemento | 1 |
| 602017 | | | antracite | 1 |
| 602018 | | | corda | 1 |

| CODICE | EURO/PZ | VERSIONE | | PZ |
|--------|---------|---------------|-----------|----|
| | | Dimensioni mm | Finitura | |
| 602020 | | 700 x 1300 | bianco | 1 |
| 602021 | | | cemento | 1 |
| 602022 | | | antracite | 1 |
| 602023 | | | corda | 1 |

| CODICE | EURO/PZ | VERSIONE | | PZ |
|--------|---------|---------------|-----------|----|
| | | Dimensioni mm | Finitura | |
| 602025 | | 700 x 1400 | bianco | 1 |
| 602026 | | | cemento | 1 |
| 602027 | | | antracite | 1 |
| 602028 | | | corda | 1 |

| CODICE | EURO/PZ | VERSIONE | | PZ |
|--------|---------|---------------|-----------|----|
| | | Dimensioni mm | Finitura | |
| 602030 | | 700 x 1500 | bianco | 1 |
| 602031 | | | cemento | 1 |
| 602032 | | | antracite | 1 |
| 602033 | | | corda | 1 |

| CODICE | EURO/PZ | VERSIONE | | PZ |
|--------|---------|---------------|-----------|----|
| | | Dimensioni mm | Finitura | |
| 602035 | | 700 x 1600 | bianco | 1 |
| 602036 | | | cemento | 1 |
| 602037 | | | antracite | 1 |
| 602038 | | | corda | 1 |

| CODICE | EURO/PZ | VERSIONE | | PZ |
|--------|---------|---------------|-----------|----|
| | | Dimensioni mm | Finitura | |
| 602040 | | 700 x 1700 | bianco | 1 |
| 602041 | | | cemento | 1 |
| 602042 | | | antracite | 1 |
| 602043 | | | corda | 1 |

| CODICE | EURO/PZ | VERSIONE | | PZ |
|--------|---------|---------------|-----------|----|
| | | Dimensioni mm | Finitura | |
| 602045 | | 700 x 1800 | bianco | 1 |
| 602046 | | | cemento | 1 |
| 602047 | | | antracite | 1 |
| 602048 | | | corda | 1 |

| CODICE | EURO/PZ | VERSIONE | | PZ |
|--------|---------|---------------|-----------|----|
| | | Dimensioni mm | Finitura | |
| 602050 | | 700 x 2000 | bianco | 1 |
| 602051 | | | cemento | 1 |
| 602052 | | | antracite | 1 |
| 602053 | | | corda | 1 |

Piatto doccia ZERO - 750 mm

| CODICE | EURO/PZ | VERSIONE | | PZ |
|--------|---------|---------------|-----------|----|
| | | Dimensioni mm | Finitura | |
| 602060 | | 750 x 1000 | bianco | 1 |
| 602061 | | | cemento | 1 |
| 602062 | | | antracite | 1 |
| 602063 | | | corda | 1 |

| CODICE | EURO/PZ | VERSIONE | | PZ |
|--------|---------|---------------|-----------|----|
| | | Dimensioni mm | Finitura | |
| 602070 | | 750 x 1200 | bianco | 1 |
| 602071 | | | cemento | 1 |
| 602072 | | | antracite | 1 |
| 602073 | | | corda | 1 |

| CODICE | EURO/PZ | VERSIONE | | PZ |
|--------|---------|---------------|-----------|----|
| | | Dimensioni mm | Finitura | |
| 602075 | | 750 x 1300 | bianco | 1 |
| 602076 | | | cemento | 1 |
| 602077 | | | antracite | 1 |
| 602078 | | | corda | 1 |

| CODICE | EURO/PZ | VERSIONE | | PZ |
|--------|---------|---------------|-----------|----|
| | | Dimensioni mm | Finitura | |
| 602080 | | 750 x 1400 | bianco | 1 |
| 602081 | | | cemento | 1 |
| 602082 | | | antracite | 1 |
| 602083 | | | corda | 1 |

| CODICE | EURO/PZ | VERSIONE | | PZ |
|--------|---------|---------------|-----------|----|
| | | Dimensioni mm | Finitura | |
| 602085 | | 750 x 1500 | bianco | 1 |
| 602086 | | | cemento | 1 |
| 602087 | | | antracite | 1 |
| 602088 | | | corda | 1 |

| CODICE | EURO/PZ | VERSIONE | | PZ |
|--------|---------|---------------|-----------|----|
| | | Dimensioni mm | Finitura | |
| 602090 | | 750 x 1600 | bianco | 1 |
| 602091 | | | cemento | 1 |
| 602092 | | | antracite | 1 |
| 602093 | | | corda | 1 |



| CODICE | EURO/PZ | VERSIONE | | PZ |
|--------|---------|---------------|-----------|----|
| | | Dimensioni mm | Finitura | |
| 602095 | | 750 x 1700 | bianco | 1 |
| 602096 | | | cemento | 1 |
| 602097 | | | antracite | 1 |
| 602098 | | | corda | 1 |

| CODICE | EURO/PZ | VERSIONE | | PZ |
|--------|---------|---------------|-----------|----|
| | | Dimensioni mm | Finitura | |
| 602100 | | 750 x 1800 | bianco | 1 |
| 602101 | | | cemento | 1 |
| 602102 | | | antracite | 1 |
| 602103 | | | corda | 1 |

Piatta doccia ZERO - 800 mm

| CODICE | EURO/PZ | VERSIONE | | PZ |
|--------|---------|---------------|-----------|----|
| | | Dimensioni mm | Finitura | |
| 602110 | | 800 x 800 | bianco | 1 |
| 602111 | | | cemento | 1 |
| 602112 | | | antracite | 1 |
| 602113 | | | corda | 1 |

| CODICE | EURO/PZ | VERSIONE | | PZ |
|--------|---------|---------------|-----------|----|
| | | Dimensioni mm | Finitura | |
| 602115 | | 800 x 900 | bianco | 1 |
| 602116 | | | cemento | 1 |
| 602117 | | | antracite | 1 |
| 602118 | | | corda | 1 |

| CODICE | EURO/PZ | VERSIONE | | PZ |
|--------|---------|---------------|-----------|----|
| | | Dimensioni mm | Finitura | |
| 602120 | | 800 x 1000 | bianco | 1 |
| 602121 | | | cemento | 1 |
| 602122 | | | antracite | 1 |
| 602123 | | | corda | 1 |

| CODICE | EURO/PZ | VERSIONE | | PZ |
|--------|---------|---------------|-----------|----|
| | | Dimensioni mm | Finitura | |
| 602130 | | 800 x 1200 | bianco | 1 |
| 602131 | | | cemento | 1 |
| 602132 | | | antracite | 1 |
| 602133 | | | corda | 1 |

| CODICE | EURO/PZ | VERSIONE | | PZ |
|--------|---------|---------------|-----------|----|
| | | Dimensioni mm | Finitura | |
| 602135 | | 800 x 1300 | bianco | 1 |
| 602136 | | | cemento | 1 |
| 602137 | | | antracite | 1 |
| 602138 | | | corda | 1 |

| CODICE | EURO/PZ | VERSIONE | | PZ |
|--------|---------|---------------|-----------|----|
| | | Dimensioni mm | Finitura | |
| 602140 | | 800 x 1400 | bianco | 1 |
| 602141 | | | cemento | 1 |
| 602142 | | | antracite | 1 |
| 602143 | | | corda | 1 |

| CODICE | EURO/PZ | VERSIONE | | PZ |
|--------|---------|---------------|-----------|----|
| | | Dimensioni mm | Finitura | |
| 602145 | | 800 x 1500 | bianco | 1 |
| 602146 | | | cemento | 1 |
| 602147 | | | antracite | 1 |
| 602148 | | | corda | 1 |

| CODICE | EURO/PZ | VERSIONE | | PZ |
|--------|---------|---------------|-----------|----|
| | | Dimensioni mm | Finitura | |
| 602150 | | 800 x 1600 | bianco | 1 |
| 602151 | | | cemento | 1 |
| 602152 | | | antracite | 1 |
| 602153 | | | corda | 1 |

| CODICE | EURO/PZ | VERSIONE | | PZ |
|--------|---------|---------------|-----------|----|
| | | Dimensioni mm | Finitura | |
| 602155 | | 800 x 1700 | bianco | 1 |
| 602156 | | | cemento | 1 |
| 602157 | | | antracite | 1 |
| 602158 | | | corda | 1 |

| CODICE | EURO/PZ | VERSIONE | | PZ |
|--------|---------|---------------|-----------|----|
| | | Dimensioni mm | Finitura | |
| 602160 | | 800 x 1800 | bianco | 1 |
| 602161 | | | cemento | 1 |
| 602162 | | | antracite | 1 |
| 602163 | | | corda | 1 |

| CODICE | EURO/PZ | VERSIONE | | PZ |
|--------|---------|---------------|-----------|----|
| | | Dimensioni mm | Finitura | |
| 602165 | | 800 x 2000 | bianco | 1 |
| 602166 | | | cemento | 1 |
| 602167 | | | antracite | 1 |
| 602168 | | | corda | 1 |

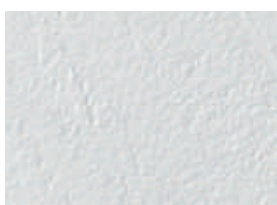

BIANCO

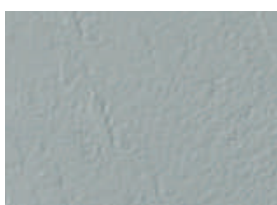

CEMENTO

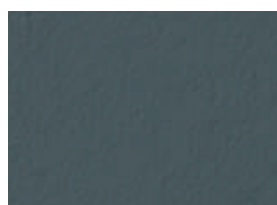

ANTRACITE

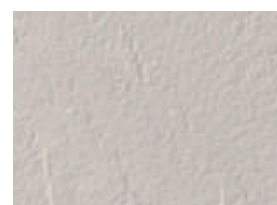

CORDA



Piatto doccia ZERO - 900 mm

| CODICE | EURO/PZ | VERSIONE | | PZ |
|--------|---------|---------------|-----------|----|
| | | Dimensioni mm | Finitura | |
| 602170 | | 900 x 900 | bianco | 1 |
| 602171 | | | cemento | 1 |
| 602172 | | | antracite | 1 |
| 602173 | | | corda | 1 |

| CODICE | EURO/PZ | VERSIONE | | PZ |
|--------|---------|---------------|-----------|----|
| | | Dimensioni mm | Finitura | |
| 602175 | | 900 x 1000 | bianco | 1 |
| 602176 | | | cemento | 1 |
| 602177 | | | antracite | 1 |
| 602178 | | | corda | 1 |

| CODICE | EURO/PZ | VERSIONE | | PZ |
|--------|---------|---------------|-----------|----|
| | | Dimensioni mm | Finitura | |
| 602185 | | 900 x 1200 | bianco | 1 |
| 602186 | | | cemento | 1 |
| 602187 | | | antracite | 1 |
| 602188 | | | corda | 1 |

| CODICE | EURO/PZ | VERSIONE | | PZ |
|--------|---------|---------------|-----------|----|
| | | Dimensioni mm | Finitura | |
| 602195 | | 900 x 1400 | bianco | 1 |
| 602196 | | | cemento | 1 |
| 602197 | | | antracite | 1 |
| 602198 | | | corda | 1 |

| CODICE | EURO/PZ | VERSIONE | | PZ |
|--------|---------|---------------|-----------|----|
| | | Dimensioni mm | Finitura | |
| 602205 | | 900 x 1600 | bianco | 1 |
| 602206 | | | cemento | 1 |
| 602207 | | | antracite | 1 |
| 602208 | | | corda | 1 |

| CODICE | EURO/PZ | VERSIONE | | PZ |
|--------|---------|---------------|-----------|----|
| | | Dimensioni mm | Finitura | |
| 602215 | | 900 x 1800 | bianco | 1 |
| 602216 | | | cemento | 1 |
| 602217 | | | antracite | 1 |
| 602218 | | | corda | 1 |

| CODICE | EURO/PZ | VERSIONE | | PZ |
|--------|---------|---------------|-----------|----|
| | | Dimensioni mm | Finitura | |
| 602220 | | 900 x 2000 | bianco | 1 |
| 602221 | | | cemento | 1 |
| 602222 | | | antracite | 1 |
| 602223 | | | corda | 1 |

Piatto doccia ZERO - Grandi formati

| CODICE | EURO/PZ | VERSIONE | | PZ |
|--------|---------|---------------|-----------|----|
| | | Dimensioni mm | Finitura | |
| 602225 | | 1000 x 1000 | bianco | 1 |
| 602226 | | | cemento | 1 |
| 602227 | | | antracite | 1 |
| 602228 | | | corda | 1 |

| CODICE | EURO/PZ | VERSIONE | | PZ |
|--------|---------|---------------|-----------|----|
| | | Dimensioni mm | Finitura | |
| 602235 | | 1000 x 1200 | bianco | 1 |
| 602236 | | | cemento | 1 |
| 602237 | | | antracite | 1 |
| 602238 | | | corda | 1 |

| CODICE | EURO/PZ | VERSIONE | | PZ |
|--------|---------|---------------|-----------|----|
| | | Dimensioni mm | Finitura | |
| 602250 | | 1000 x 1400 | bianco | 1 |
| 602251 | | | cemento | 1 |
| 602252 | | | antracite | 1 |
| 602253 | | | corda | 1 |

| CODICE | EURO/PZ | VERSIONE | | PZ |
|--------|---------|---------------|-----------|----|
| | | Dimensioni mm | Finitura | |
| 602260 | | 1000 x 1600 | bianco | 1 |
| 602261 | | | cemento | 1 |
| 602262 | | | antracite | 1 |
| 602263 | | | corda | 1 |

| CODICE | EURO/PZ | VERSIONE | | PZ |
|--------|---------|---------------|-----------|----|
| | | Dimensioni mm | Finitura | |
| 602270 | | 1000 x 1800 | bianco | 1 |
| 602271 | | | cemento | 1 |
| 602272 | | | antracite | 1 |
| 602273 | | | corda | 1 |

| CODICE | EURO/PZ | VERSIONE | | PZ |
|--------|---------|---------------|-----------|----|
| | | Dimensioni mm | Finitura | |
| 602280 | | 1000 x 2000 | bianco | 1 |
| 602281 | | | cemento | 1 |
| 602282 | | | antracite | 1 |
| 602283 | | | corda | 1 |

| CODICE | EURO/PZ | VERSIONE | | PZ |
|--------|---------|---------------|-----------|----|
| | | Dimensioni mm | Finitura | |
| 602290 | | 1000 x 2150 | bianco | 1 |
| 602291 | | | cemento | 1 |
| 602292 | | | antracite | 1 |
| 602293 | | | corda | 1 |

| CODICE | EURO/PZ | VERSIONE | | PZ |
|--------|---------|---------------|-----------|----|
| | | Dimensioni mm | Finitura | |
| 602295 | | 1100 x 2000 | bianco | 1 |
| 602296 | | | cemento | 1 |
| 602297 | | | antracite | 1 |
| 602298 | | | corda | 1 |

Piatto doccia ZERO - angolo tondo

PIATTO DOCCIA ANGOLO TONDO RAGGIO 55 CM

| CODICE | EURO/PZ | VERSIONE | | PZ |
|--------|---------|---------------|-----------|----|
| | | Dimensioni mm | Finitura | |
| 602315 | | 900x900 | bianco | 1 |
| 602316 | | | cemento | 1 |
| 602317 | | | antracite | 1 |
| 602318 | | | corda | 1 |

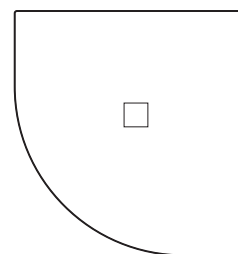

Piatto doccia ZERO - Accessori e ricambi

| CODICE | EURO/PZ | VERSIONE | Peso ml | PZ |
|--------|---------|---|---------|----|
| | | | | |
| 603515 | | Mastice in poliuretano - color bianco | 300 | 1 |
| 603516 | | Mastice in poliuretano - color cemento | 300 | 1 |
| 603517 | | Mastice in poliuretano - color antracite | 300 | 1 |
| 603518 | | Mastice in poliuretano - color corda | 300 | 1 |
| 602325 | | Kit di ripristino - piccolo - color bianco | 125 | 1 |
| 602326 | | Kit di ripristino - piccolo - color cemento | 125 | 1 |
| 602327 | | Kit di ripristino - piccolo - color antracite | 125 | 1 |
| 602328 | | Kit di ripristino - piccolo - color corda | 125 | 1 |

| CODICE | EURO/PZ | VERSIONE | PZ |
|--------|---------|--------------------------------------|----|
| | | | |
| 606152 | | Piletta di scarico ribassata Ø 90 mm | 1 |
| 602335 | | Griglia in inox | 1 |

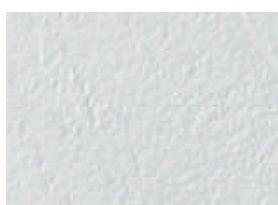
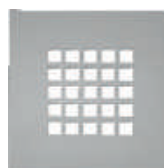

BIANCO



CEMENTO



ANTRACITE

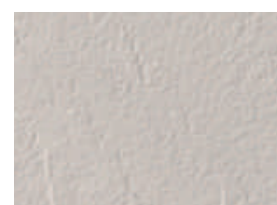

CORDA

Canalette Linea Inox Style

Piccole, grandi, quadrate, sobrie. **Inox Style** offre una linea completa di canalette di scarico per doccia a filo pavimento. Grazie all'**altezza di soli 63 mm** sono particolarmente indicate nelle ristrutturazioni.

Interamente in acciaio inox con cornice specifica per un ottimo collegamento con la guaina, liquida o morbida, a garanzia di una totale impermeabilizzazione. Concepite per poter essere installate in posizione centrale o laterale rispetto al piatto doccia (**serie Luxury**) ma anche tra il piatto doccia e la parete (**serie Ram**).

VANTAGGI

FACILE DA MONTARE

ANTIBATTERICO E ANTIMUFFA

ALTEZZA REGOLABILE

8 MISURE DISPONIBILI

8 GRIGLIE DISPONIBILI

RESISTE AI RAGGI UV

ADATTO A PERSONE CON DIFFICOLTÀ MOTORIE

Linea Luxury rettangolare e quadrata

Soluzioni di installazione: posizione centrale o laterale



SOLUZIONI DI INSTALLAZIONE

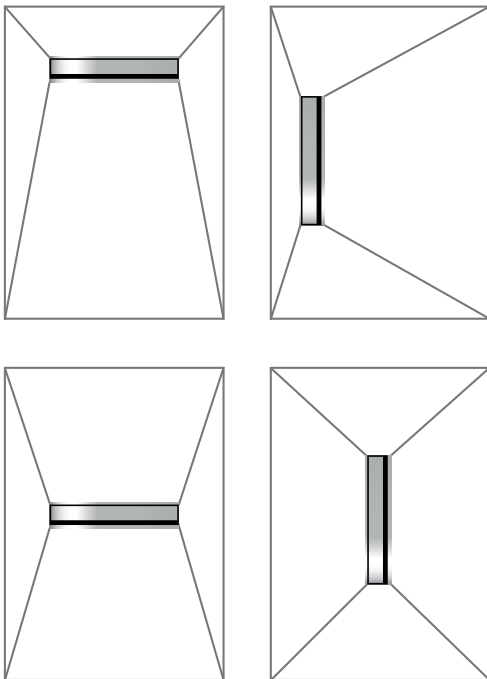

Linea Ram rettangolare e triangolare

Soluzioni di installazione: filo muro (con scarico orizzontale)



SOLUZIONI DI INSTALLAZIONE

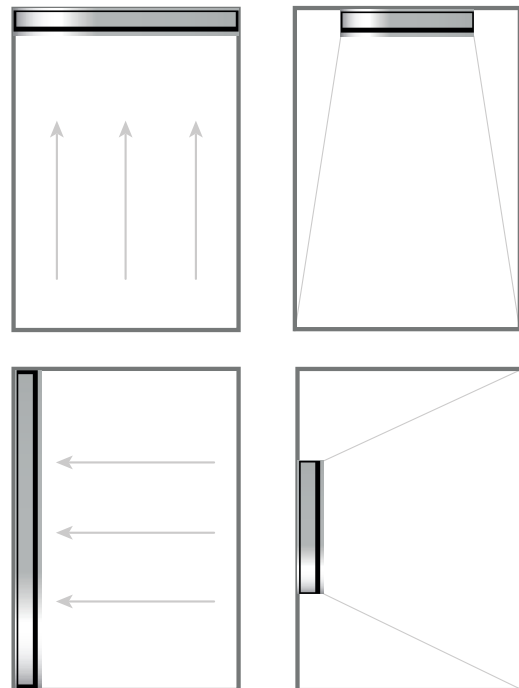

Sifone di scarico in acciaio inox incluso



SIFONE ANTIODORE VALVE
Sifone antiodore in acciaio inox progettato con valvola automatica di chiusura contro la fuoriuscita di eventuali cattivi odori Cod. 606151

SISTEMA DI SCARICO INOX STYLE

Linea Luxury Rettangolare

SISTEMI DI SCARICO

INOX STYLE - Linea Luxury - Rettangolare

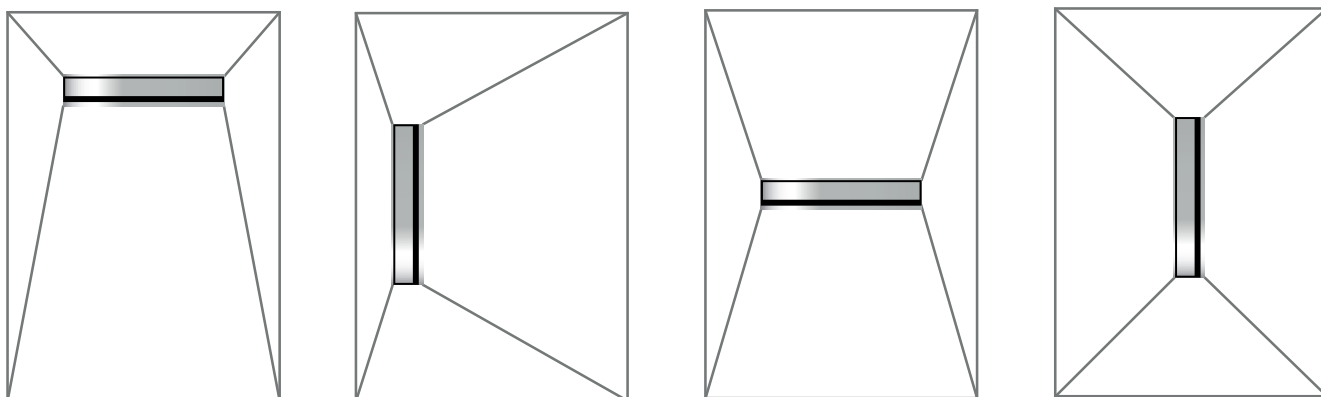

Caratteristiche

| | |
|---------------------|-----------------------------|
| Materiale | acciaio inox spessore 20/10 |
| Scarico | DN 50 |
| Capacità di scarico | 55 l/min |
| Colore | acciaio |
| Dimensioni | A 80 x H 63 ÷ 115 mm |

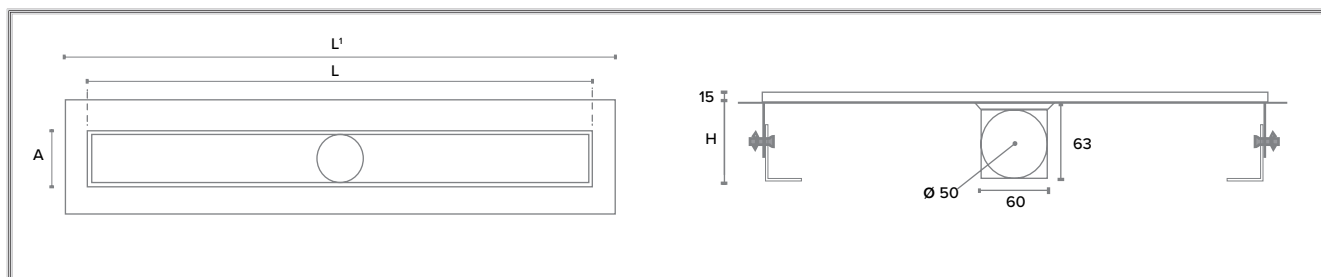

**Linea Luxury
Rettangolare**

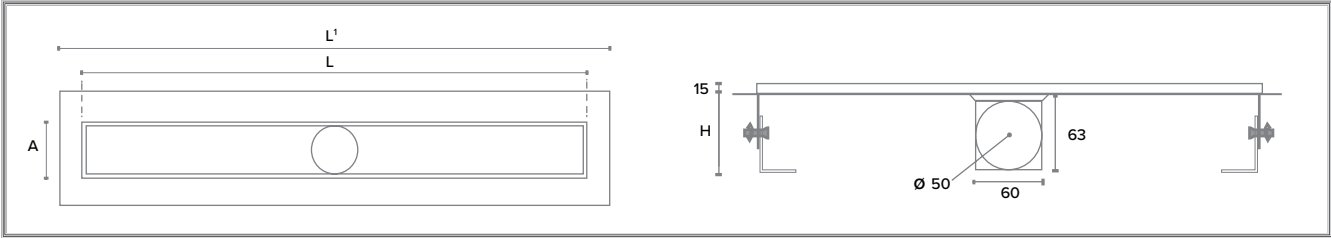

FULL INOX PIASTRELLABILE

| CODICE | EURO/PZ | VERSIONE | | PZ |
|--------|---------|----------|---------|----|
| | | L (mm) | L' (mm) | |
| 603080 | | 485 | 535 | 1 |
| 603081 | | 585 | 635 | 1 |
| 603082 | | 685 | 735 | 1 |
| 603083 | | 785 | 835 | 1 |
| 603084 | | 885 | 935 | 1 |
| 603085 | | 985 | 1035 | 1 |
| 603086 | | 1085 | 1135 | 1 |
| 603087 | | 1185 | 1235 | 1 |



FULL INOX LUCIDO



| CODICE | EURO/PZ | VERSIONE | | PZ |
|--------|---------|----------|---------|----|
| | | L (mm) | L' (mm) | |
| 603000 | | 485 | 535 | 1 |
| 603001 | | 585 | 635 | 1 |
| 603002 | | 685 | 735 | 1 |
| 603003 | | 785 | 835 | 1 |
| 603004 | | 885 | 935 | 1 |
| 603005 | | 985 | 1035 | 1 |
| 603006 | | 1085 | 1135 | 1 |
| 603007 | | 1185 | 1235 | 1 |

FULL INOX SATINATO



| CODICE | EURO/PZ | VERSIONE | | PZ |
|--------|---------|----------|---------|----|
| | | L (mm) | L' (mm) | |
| 603008 | | 485 | 535 | 1 |
| 603009 | | 585 | 635 | 1 |
| 603010 | | 685 | 735 | 1 |
| 603011 | | 785 | 835 | 1 |
| 603012 | | 885 | 935 | 1 |
| 603013 | | 985 | 1035 | 1 |
| 603014 | | 1085 | 1135 | 1 |
| 603015 | | 1185 | 1235 | 1 |

FULL INOX CON INCISIONE "SQUARE 1"



| CODICE | EURO/PZ | VERSIONE | | PZ |
|--------|---------|----------|---------|----|
| | | L (mm) | L' (mm) | |
| 603016 | | 485 | 535 | 1 |
| 603017 | | 585 | 635 | 1 |
| 603018 | | 685 | 735 | 1 |
| 603019 | | 785 | 835 | 1 |
| 603020 | | 885 | 935 | 1 |
| 603021 | | 985 | 1035 | 1 |
| 603022 | | 1085 | 1135 | 1 |
| 603023 | | 1185 | 1235 | 1 |

FULL INOX CON INCISIONE "SQUARE 2"



| CODICE | EURO/PZ | VERSIONE | | PZ |
|--------|---------|----------|---------|----|
| | | L (mm) | L' (mm) | |
| 603024 | | 485 | 535 | 1 |
| 603025 | | 585 | 635 | 1 |
| 603026 | | 685 | 735 | 1 |
| 603027 | | 785 | 835 | 1 |
| 603028 | | 885 | 935 | 1 |
| 603029 | | 985 | 1035 | 1 |
| 603030 | | 1085 | 1135 | 1 |
| 603031 | | 1185 | 1235 | 1 |

FULL INOX CON INCISIONE "RECTANGLES"



| CODICE | EURO/PZ | VERSIONE | | PZ |
|--------|---------|----------|---------------------|----|
| | | L (mm) | L ¹ (mm) | |
| 603032 | | 485 | 535 | 1 |
| 603033 | | 585 | 635 | 1 |
| 603034 | | 685 | 735 | 1 |
| 603035 | | 785 | 835 | 1 |
| 603036 | | 885 | 935 | 1 |
| 603037 | | 985 | 1035 | 1 |
| 603038 | | 1085 | 1135 | 1 |
| 603039 | | 1185 | 1235 | 1 |

FULL INOX CON INCISIONE "CIRCLES"



| CODICE | EURO/PZ | VERSIONE | | PZ |
|--------|---------|----------|---------------------|----|
| | | L (mm) | L ¹ (mm) | |
| 603040 | | 485 | 535 | 1 |
| 603041 | | 585 | 635 | 1 |
| 603042 | | 685 | 735 | 1 |
| 603043 | | 785 | 835 | 1 |
| 603044 | | 885 | 935 | 1 |
| 603045 | | 985 | 1035 | 1 |
| 603046 | | 1085 | 1135 | 1 |
| 603047 | | 1185 | 1235 | 1 |

FULL INOX CON LASTRA IN CRISTALLO BIANCO



| CODICE | EURO/PZ | VERSIONE | | PZ |
|--------|---------|----------|---------------------|----|
| | | L (mm) | L ¹ (mm) | |
| 603072 | | 485 | 535 | 1 |
| 603073 | | 585 | 635 | 1 |
| 603074 | | 685 | 735 | 1 |
| 603075 | | 785 | 835 | 1 |
| 603076 | | 885 | 935 | 1 |
| 603077 | | 985 | 1035 | 1 |
| 603078 | | 1085 | 1135 | 1 |
| 603079 | | 1185 | 1235 | 1 |

FULL INOX CON LASTRA IN CRISTALLO NERO



| CODICE | EURO/PZ | VERSIONE | | PZ |
|--------|---------|----------|---------------------|----|
| | | L (mm) | L ¹ (mm) | |
| 603064 | | 485 | 535 | 1 |
| 603065 | | 585 | 635 | 1 |
| 603066 | | 685 | 735 | 1 |
| 603067 | | 785 | 835 | 1 |
| 603068 | | 885 | 935 | 1 |
| 603069 | | 985 | 1035 | 1 |
| 603070 | | 1085 | 1135 | 1 |
| 603071 | | 1185 | 1235 | 1 |

FULL INOX CON INCISIONE "VENICE 1"



| CODICE | EURO/PZ | VERSIONE | | PZ |
|--------|---------|----------|---------------------|----|
| | | L (mm) | L ¹ (mm) | |
| 603048 | | 485 | 535 | 1 |
| 603049 | | 585 | 635 | 1 |
| 603050 | | 685 | 735 | 1 |
| 603051 | | 785 | 835 | 1 |
| 603052 | | 885 | 935 | 1 |
| 603053 | | 985 | 1035 | 1 |
| 603054 | | 1085 | 1135 | 1 |
| 603055 | | 1185 | 1235 | 1 |

FULL INOX CON INCISIONE "VENICE 2"



| CODICE | EURO/PZ | VERSIONE | | PZ |
|--------|---------|----------|---------------------|----|
| | | L (mm) | L ¹ (mm) | |
| 603056 | | 485 | 535 | 1 |
| 603057 | | 585 | 635 | 1 |
| 603058 | | 685 | 735 | 1 |
| 603059 | | 785 | 835 | 1 |
| 603060 | | 885 | 935 | 1 |
| 603061 | | 985 | 1035 | 1 |
| 603062 | | 1085 | 1135 | 1 |
| 603063 | | 1185 | 1235 | 1 |

SISTEMA DI SCARICO INOX STYLE

Linea RAM Rettangolare

Soluzioni di installazione: filo muro (con scarico orizzontale)

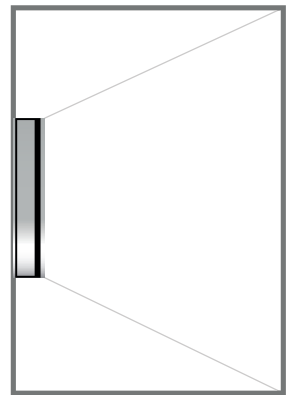
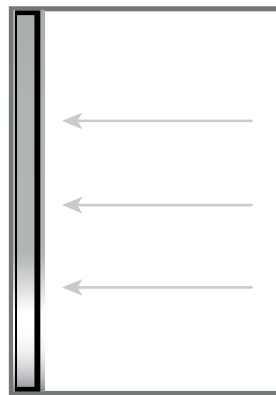
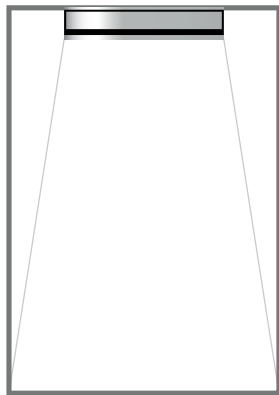
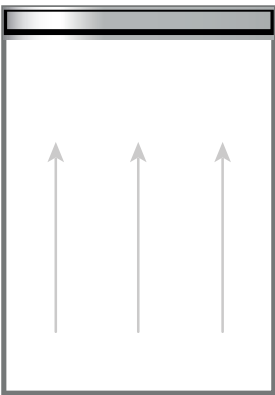

Caratteristiche

| | |
|---------------------|-----------------------------|
| Materiale | acciaio inox spessore 20/10 |
| Scarico | DN 50 |
| Capacità di scarico | 55 l/min |
| Colore | acciaio |
| Dimenszioni | A 80 mm x H 63 ÷ 115 mm |

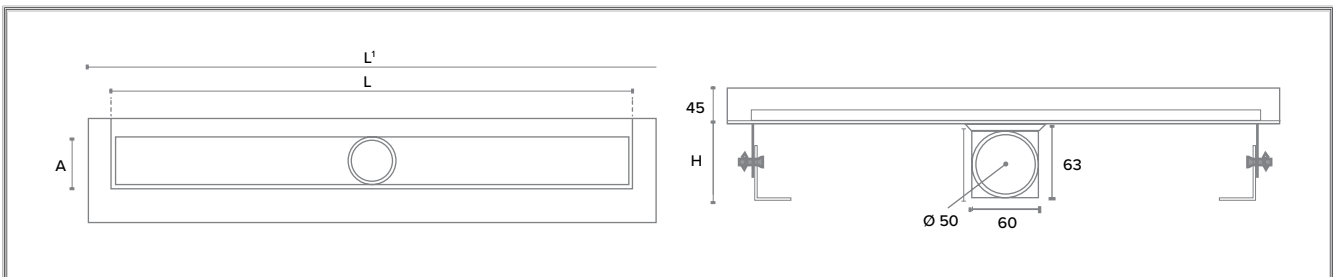

FULL INOX LUCIDO

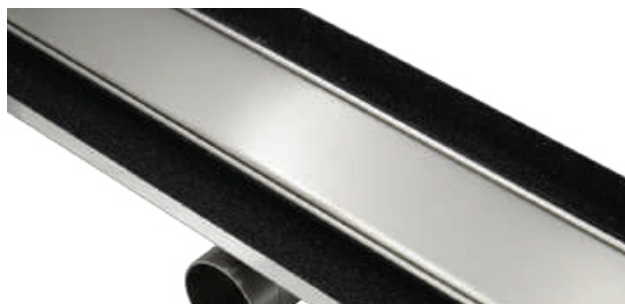

| CODICE | EURO/PZ | VERSIONE | | PZ |
|--------|---------|-----------|------------------------|----|
| | | L (mm) | L ¹ (mm) | |
| 603300 | | 485 | 535 | 1 |
| 603301 | | 585 | 635 | 1 |
| 603302 | | 685 | 735 | 1 |
| 603303 | | 785 | 835 | 1 |
| 603304 | | 885 | 935 | 1 |
| 603305 | | 985 | 1035 | 1 |
| 603306 | | 1085 | 1135 | 1 |
| 603307 | | 1185 | 1235 | 1 |

FULL INOX SATINATO

| CODICE | EURO/PZ | VERSIONE | | PZ |
|--------|---------|-----------|------------------------|----|
| | | L (mm) | L ¹ (mm) | |
| 603308 | | 485 | 535 | 1 |
| 603309 | | 585 | 635 | 1 |
| 603310 | | 685 | 735 | 1 |
| 603311 | | 785 | 835 | 1 |
| 603312 | | 885 | 935 | 1 |
| 603313 | | 985 | 1035 | 1 |
| 603314 | | 1085 | 1135 | 1 |
| 603315 | | 1185 | 1235 | 1 |

FULL INOX PIASTRELLABILE

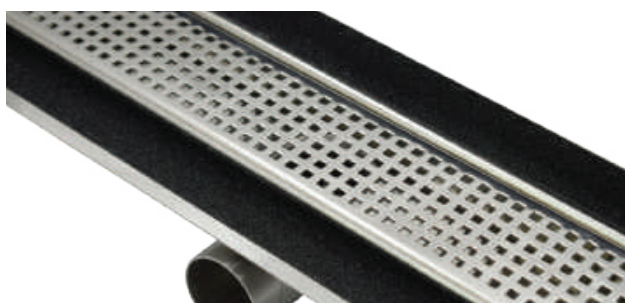

| CODICE | EURO/PZ | VERSIONE | | PZ |
|--------|---------|-----------|------------------------|----|
| | | L (mm) | L ¹ (mm) | |
| 603380 | | 485 | 535 | 1 |
| 603381 | | 585 | 635 | 1 |
| 603382 | | 685 | 735 | 1 |
| 603383 | | 785 | 835 | 1 |
| 603384 | | 885 | 935 | 1 |
| 603385 | | 985 | 1035 | 1 |
| 603386 | | 1085 | 1135 | 1 |
| 603387 | | 1185 | 1235 | 1 |

FULL INOX CON INCISIONE "SQUARE 1"

| CODICE | EURO/PZ | VERSIONE | | PZ |
|--------|---------|-----------|------------------------|----|
| | | L (mm) | L ¹ (mm) | |
| 603316 | | 485 | 535 | 1 |
| 603317 | | 585 | 635 | 1 |
| 603318 | | 685 | 735 | 1 |
| 603319 | | 785 | 835 | 1 |
| 603320 | | 885 | 935 | 1 |
| 603321 | | 985 | 1035 | 1 |
| 603322 | | 1085 | 1135 | 1 |
| 603323 | | 1185 | 1235 | 1 |

FULL INOX CON LASTRA IN CRISTALLO BIANCO

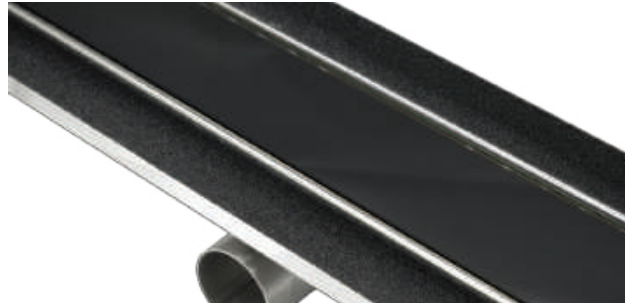
| CODICE | EURO/PZ | VERSIONE | | PZ |
|--------|---------|-----------|------------------------|----|
| | | L (mm) | L ¹ (mm) | |
| 603372 | | 485 | 535 | 1 |
| 603373 | | 585 | 635 | 1 |
| 603374 | | 685 | 735 | 1 |
| 603375 | | 785 | 835 | 1 |
| 603376 | | 885 | 935 | 1 |
| 603377 | | 985 | 1035 | 1 |
| 603378 | | 1085 | 1135 | 1 |
| 603379 | | 1185 | 1235 | 1 |

FULL INOX CON LASTRA IN CRISTALLO NERO

| CODICE | EURO/PZ | VERSIONE | | PZ |
|--------|---------|-----------|------------------------|----|
| | | L (mm) | L ¹ (mm) | |
| 603364 | | 485 | 535 | 1 |
| 603365 | | 585 | 635 | 1 |
| 603366 | | 685 | 735 | 1 |
| 603367 | | 785 | 835 | 1 |
| 603368 | | 885 | 935 | 1 |
| 603369 | | 985 | 1035 | 1 |
| 603370 | | 1085 | 1135 | 1 |
| 603371 | | 1185 | 1235 | 1 |



Linea LUXURY Quadrata

FULL INOX CON INCISIONE "SQUARES 1"
200 X 200

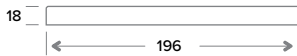
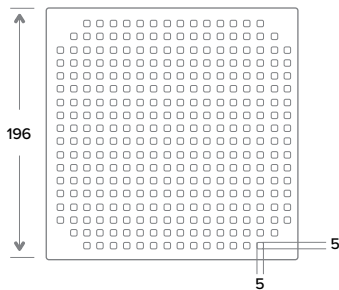
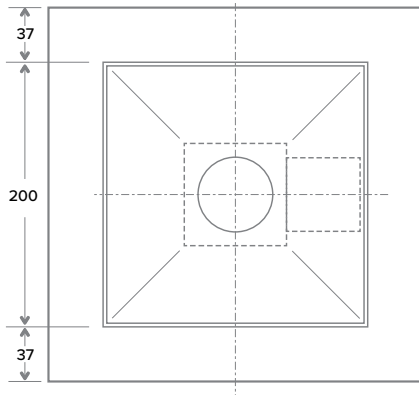
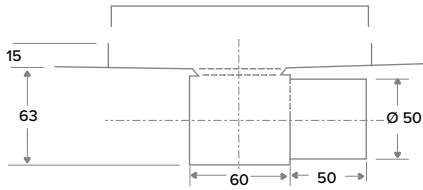
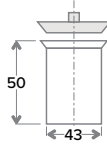
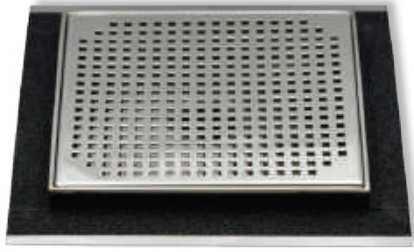

FULL INOX PIASTRELLABILE
200 X 200

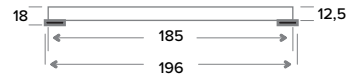
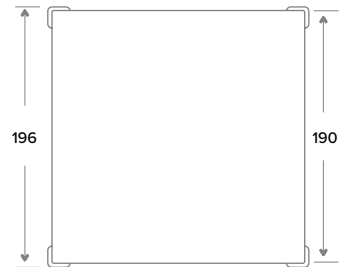
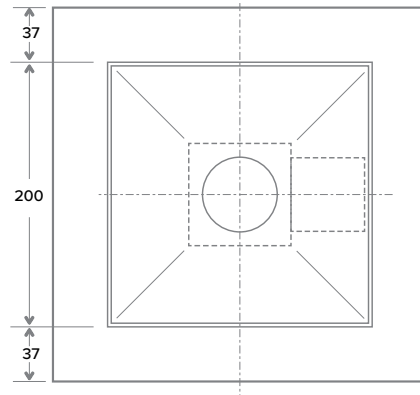
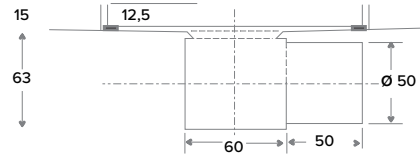
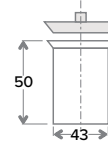

Caratteristiche

| | |
|---------------------|-----------------------------|
| Materiale | acciaio inox spessore 20/10 |
| Scarico | DN 50 |
| Capacità di scarico | 55 l/min |
| Colore | acciaio |
| Dimensioni | A 200 x L 200 x H 63 mm |

| CODICE | EURO/PZ | PZ |
|--------|---------|----|
| 603090 | | 1 |

Caratteristiche

| | |
|---------------------|-----------------------------|
| Materiale | acciaio inox spessore 20/10 |
| Scarico | DN 50 |
| Capacità di scarico | 55 l/min |
| Colore | acciaio |
| Dimensioni | A 200 x L 200 x H 63 mm |

| CODICE | EURO/PZ | PZ |
|--------|---------|----|
| 603091 | | 1 |

SISTEMA DI SCARICO INOX STYLE

Linea RAM Triangolare

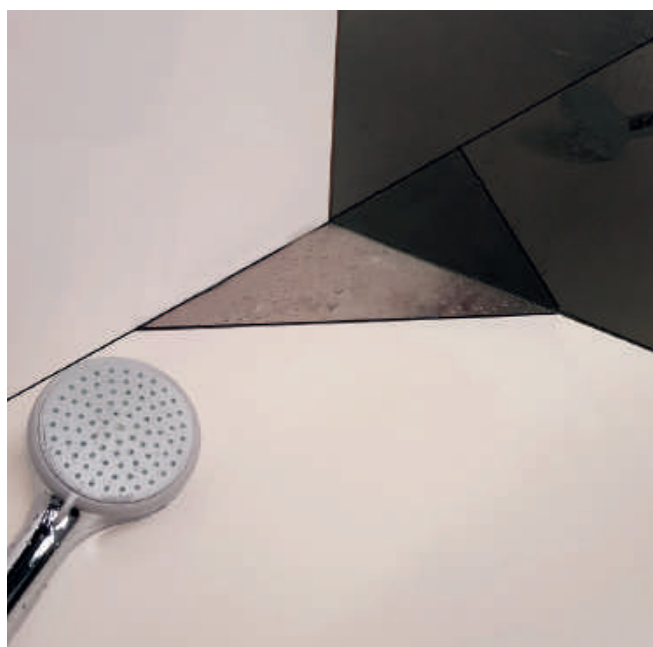
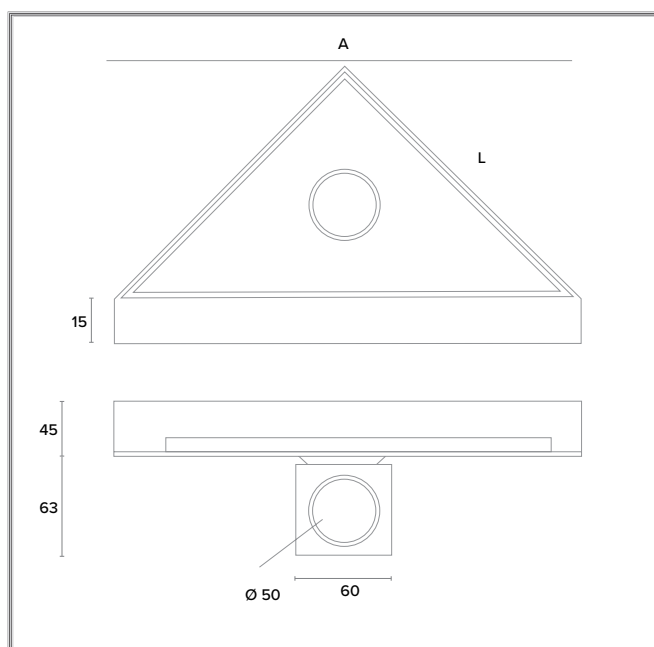

Caratteristiche

| | |
|------------|-----------------------------|
| Materiale | acciaio inox spessore 20/10 |
| Colore | acciaio |
| Dimensioni | A 226 x L 315 x H 63 mm |

FULL INOX CON INCISIONE "CIRCLES"



| CODICE | EURO/PZ | PZ |
|--------|---------|----|
| 603390 | | 1 |

FULL INOX PIASTRELLABILE



| CODICE | EURO/PZ | PZ |
|--------|---------|----|
| 603391 | | 1 |

SISTEMA DI SCARICO INOX STYLE
Chiusino sifonato
LINEA LUXURY
Quadrata

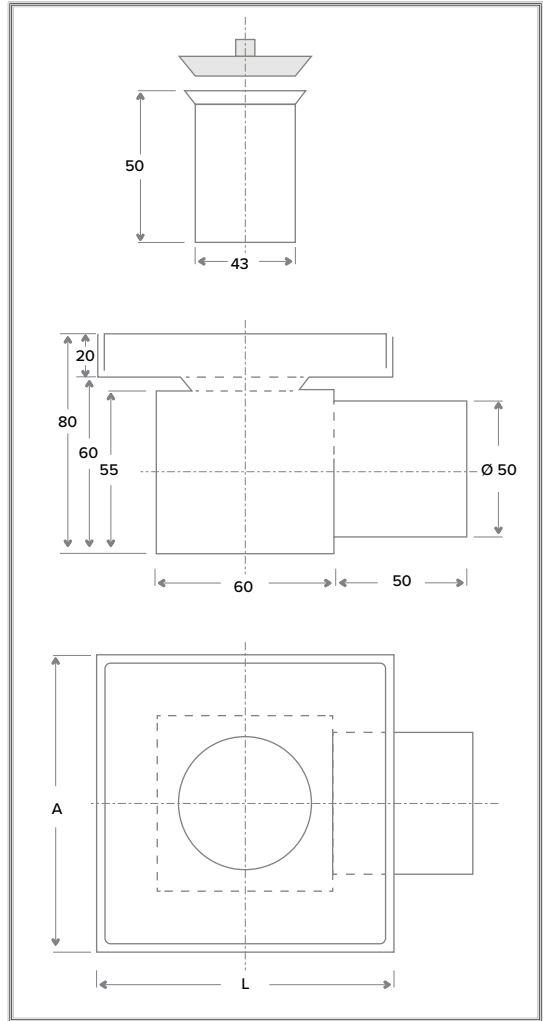

Caratteristiche

| | |
|---------------------|-----------------------------|
| Materiale | acciaio inox spessore 20/10 |
| Scarico | DN 50 |
| Capacità di scarico | 55 l/min |
| Colore | acciaio |
| Dimensioni | A 100 x L 100 x H 63 mm |



FULL INOX CON LASTRA PIASTRELLABILE

| CODICE | EURO/PZ | PZ |
|--------|---------|----|
| 603116 | | 1 |

FULL INOX CON INCISIONE
100 X 100

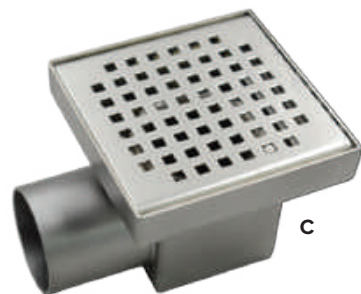
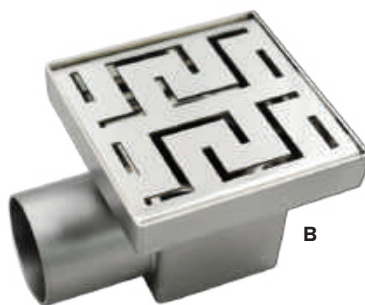

| CODICE | EURO/PZ | VERSIONE | PZ |
|--------|---------|--------------|----|
| | | □ Incisione | |
| 603110 | | A Rectangles | 1 |
| 603112 | | B Venice2 | 1 |
| 603114 | | C Square1 | 1 |

SISTEMA DI SCARICO PER DOCCIA INOX SLOT

La funzionalità nella sua forma più elegante e moderna racchiusa in una semplice fessura. Minimale, semplice e pulita la linea INOX SLOT è stata progettata in ogni minimo particolare per non dover scendere a compromessi tra funzionalità e design. Tutti i modelli della linea INOX SLOT sono studiati in ogni minimo particolare e possono essere agevolmente tagliati su misura direttamente in loco.

VANTAGGI

**SEZIONABILE IN
OPERA**

**ANTIBATTERICO
E ANTIMUFFA**

**ALTEZZA
REGOLABILE**

**ADATTO A PERSONE CON
DIFFICOLTÀ MOTORIE**

INOX SLOT FLOOR

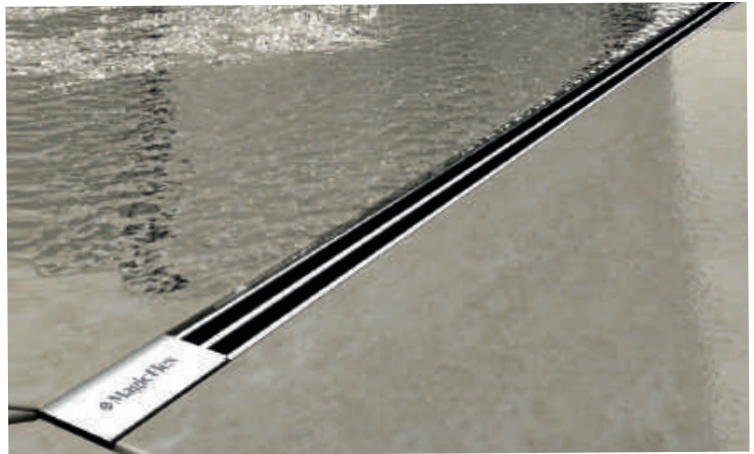
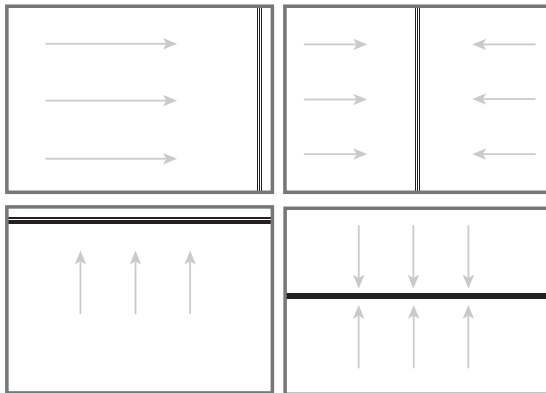

INOX SLOT WALL

Installazione a parete (con scarico verticale)

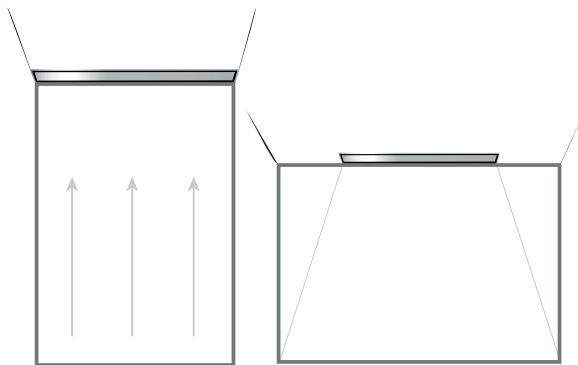

INOX SLOT FLOOR 2DS

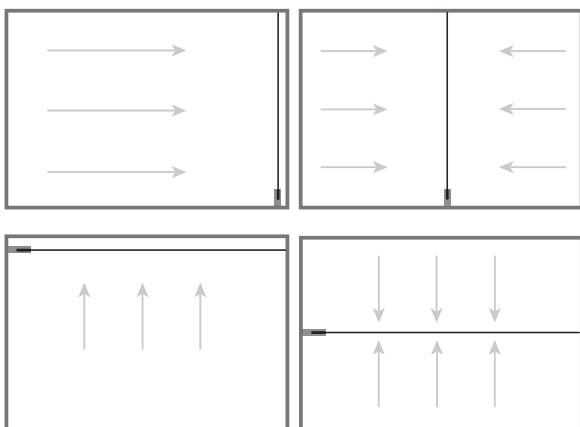



SISTEMA DI SCARICO PER DOCCIA INOX SLOT FLOOR sezionabile in opera

Caratteristiche

| | |
|------------------------------|--------------|
| Materiale | acciaio inox |
| Scarico | DN 50 |
| Capacità di scarico | 55 l/min |
| Colore | acciaio |
| Regolazione supporto griglia | H 12 ÷ 24 mm |
| Altezza regolabile | 64 ÷ 90 mm |
| Lunghezza | 1000 mm |

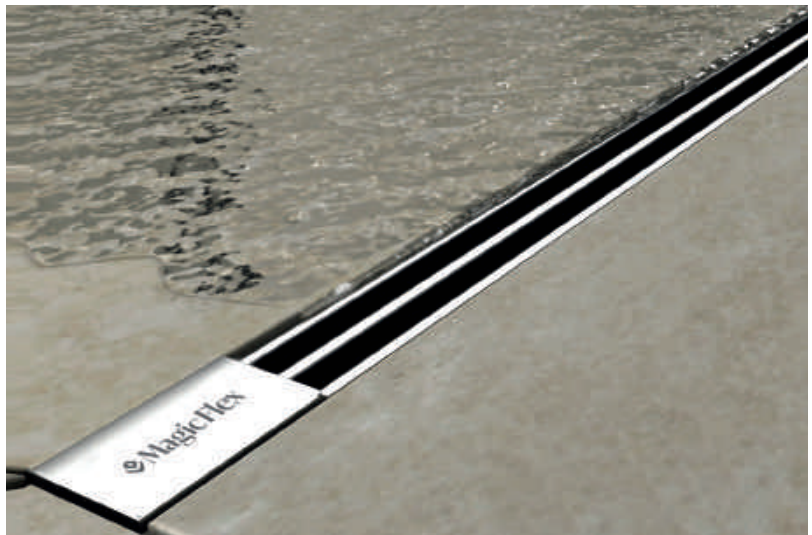

DI SERIE (INCLUSI) - confezione unica



MODULO AD INCASSO corredato di guaina e piedini di ancoraggio regolabili in altezza



Supporto della griglia regolabile in altezza da 12 a 24 mm



Progettati per essere sezionati su misura in opera



SIFONE DI SCARICO ribassato orientabile



SUPPORTO PER GRIGLIA IN REGOLABILE

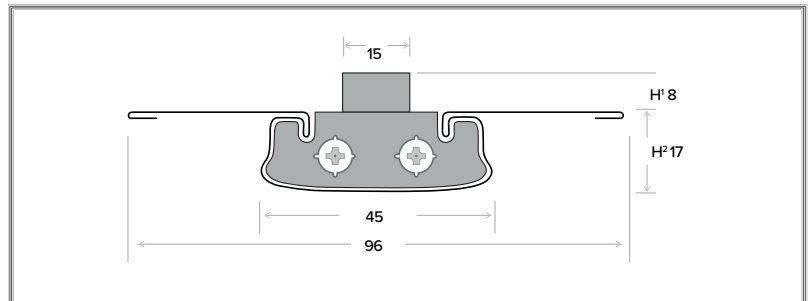
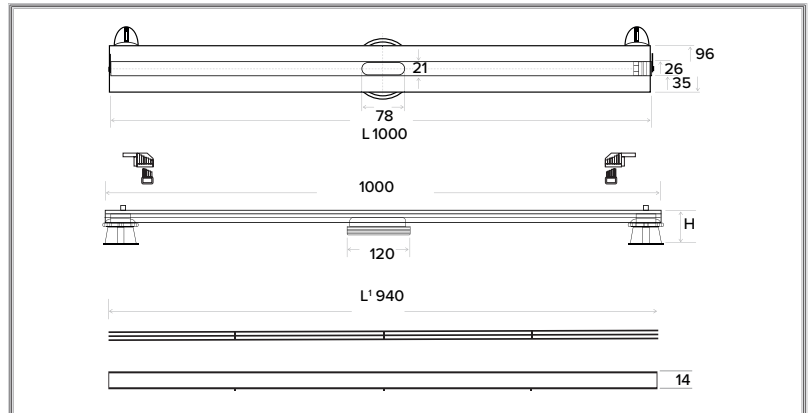

| CODICE | EURO/PZ | VERSIONE | | | | | PZ |
|--------|---------|----------|---------|---------|---------|---------|----|
| | | L (mm) | L' (mm) | H | H' (mm) | H² (mm) | |
| 603411 | | 1000 | 940 | 64 ÷ 90 | 8 | 17 | 1 |



SISTEMA DI SCARICO PER DOCCIA INOX SLOT WALL

sezionabile in opera
Installazione a parete (con scarico verticale)

Caratteristiche

| | |
|---------------------|------------------|
| Materiale | acciaio inox |
| Scarico | DN 50 |
| Capacità di scarico | 55 l/min |
| Colore | acciaio satinato |
| Altezza regolabile | 60 ÷ 125 mm |
| Lunghezza | 1000 mm |

DI SERIE (INCLUSI) - confezione unica



MODULO AD INCASSO corredato di guaina e piedini di ancoraggio regolabili in altezza



SUPPORTO PER GRIGLIA IN ACCIAIO INOX tagliabile su misura in opera



GRIGLIA IN ACCIAIO INOX tagliabile su misura in opera e rimovibile



GRIGLIA FERMA CAPELLI in acciaio inox



SIFONE DI SCARICO ribassato orientabile



Progettati per essere sezionati su misura in opera

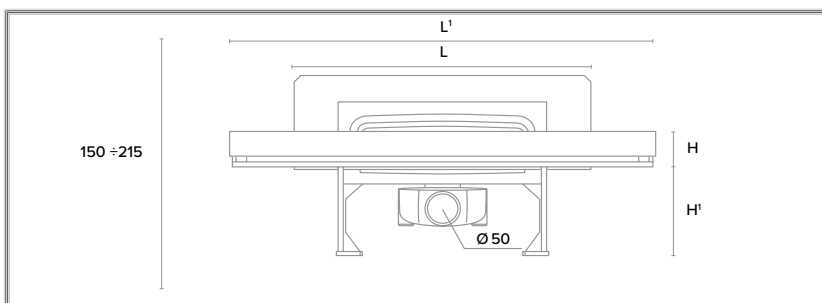
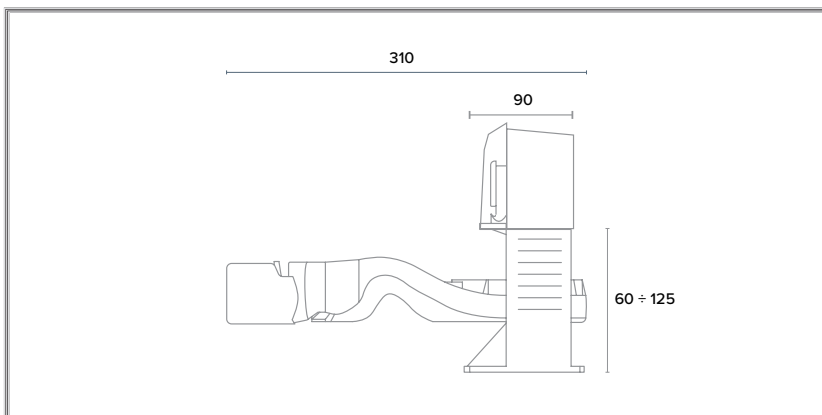

| CODICE | EURO/PZ | VERSIONE | | | | PZ |
|--------|---------|----------|---------|--------|----------|----|
| | | L (mm) | L' (mm) | H (mm) | H' (mm) | |
| 603401 | | 295 | 1000 | 40 | 60 ÷ 125 | 1 |

SISTEMA DI SCARICO PER DOCCIA
INOX SLOT FLOOR 2DS
 (reversibile)

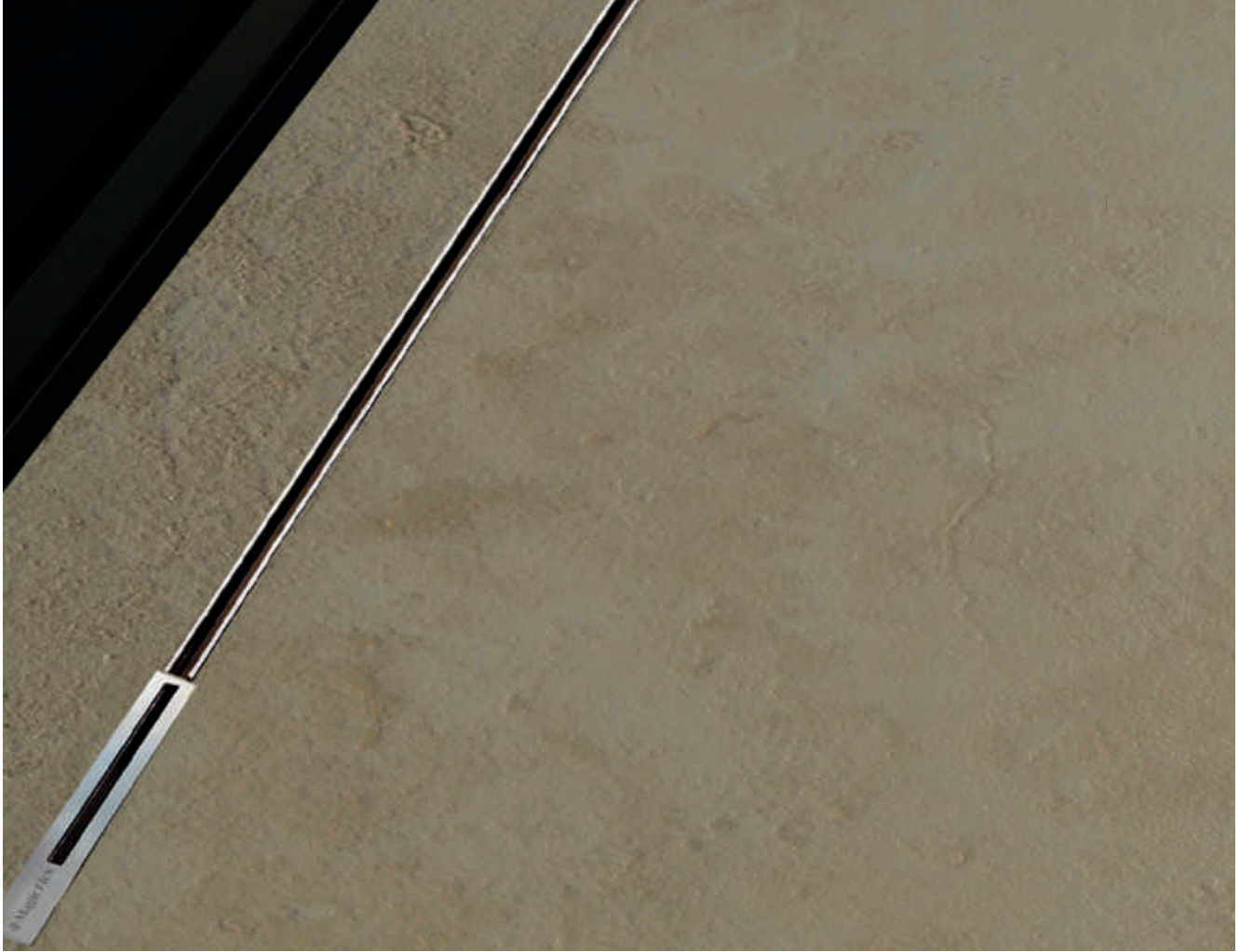

Caratteristiche

| | |
|---------------------|--------------|
| Materiale | acciaio inox |
| Scarico | DN 50 |
| Capacità di scarico | 55 l/min |
| Colore | acciaio |
| Altezza regolabile | 64 ÷ 90 mm |
| Lunghezza | 2000 mm |

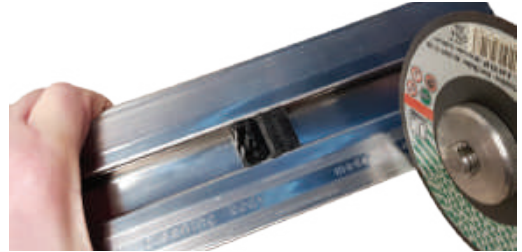

Possono essere agevolmente tagliati su misura direttamente in opera

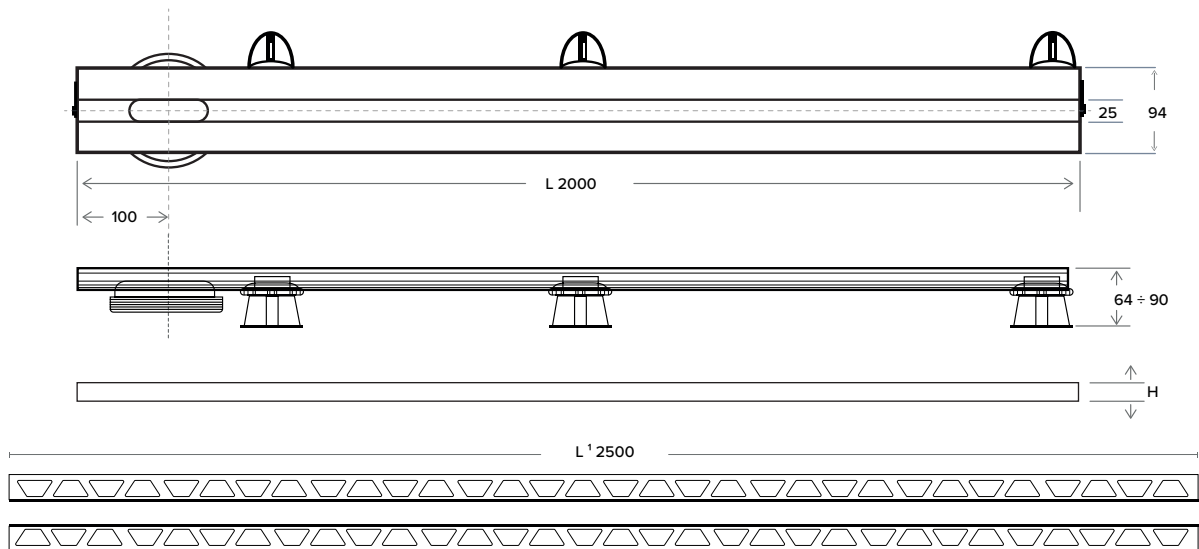

Composto da:

- Modulo ad incasso corredato di guaina e piedini di ancoraggio regolabili in altezza
- Sifone di scarico ribassato orientabile
- Griglia ferma capelli in acciaio inox
- Profili per rivestimento ceramico (vedi versione)

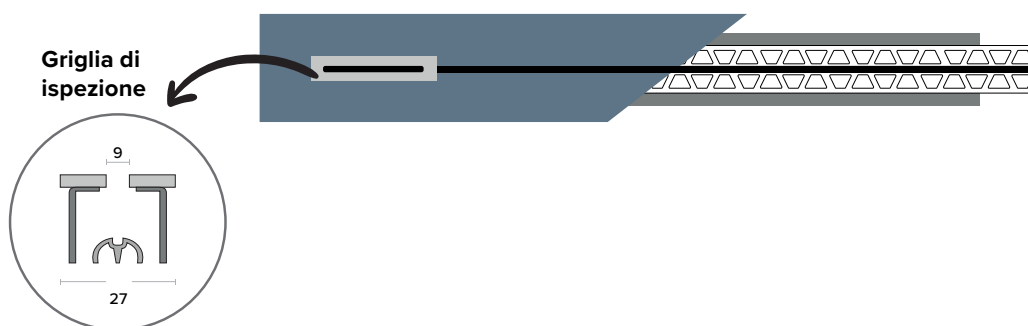
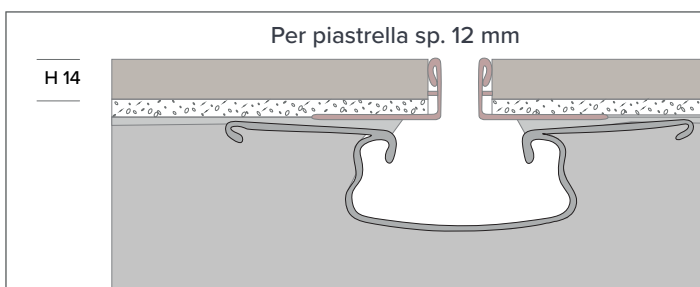
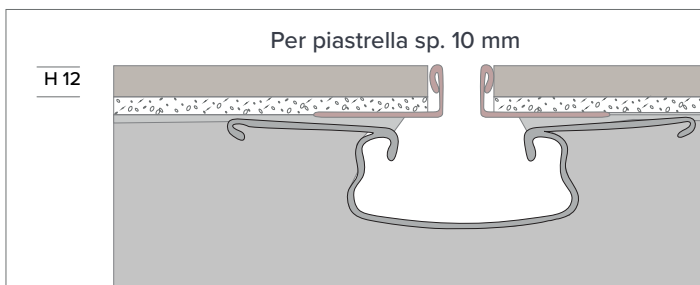
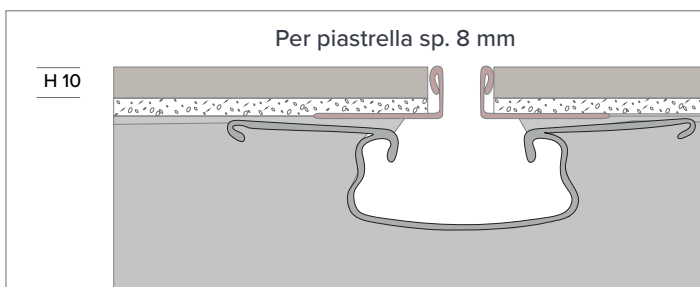
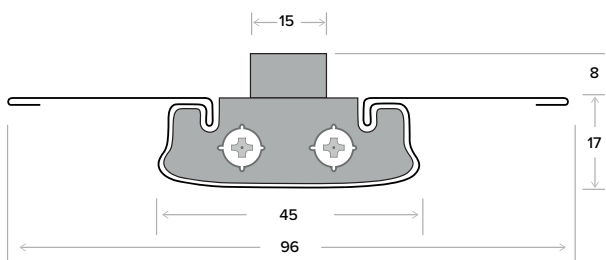

| CODICE | EURO/PZ | VERSIONE | | PZ |
|--------|---------|----------|--------|----|
| | | L (mm) | H (mm) | |
| 603415 | | 2000 | 10 | 1 |
| 603416 | | | 12 | 1 |
| 603417 | | | 14 | 1 |

PROFILI DI RICAMBIO IN ACCIAIO INOX

| CODICE | EURO/PZ | VERSIONE | | PZ. |
|--------|---------|----------|--------------------------|-----|
| | | L' (mm) | H' (mm) | |
| 603500 | | 2500 | 10 per piastrella sp. 8 | 1 |
| 603501 | | | 12 per piastrella sp. 10 | 1 |
| 603502 | | | 14 per piastrella sp. 12 | 1 |

FLESSIBILI DOCCIA SPRING LINE

Unico sul mercato per la novità, per il design e per i materiali utilizzati



Realizzato in filo di acciaio Inox AISI 304 di diametro 1 mm elettrolucidato e lavorato artigianalmente per ottenere quel particolare effetto cromatico.

Per realizzare un flessibile doccia da un metro e mezzo vengono utilizzati 78 metri di filo di acciaio.

Prodotto coperto da brevetto.

Maglia non estensibile.

Caratteristiche

| | |
|--------------------|-----------------------|
| Materiale | acciaio inox AISI 304 |
| Colore maglia | cromo |
| Finiture terminali | ottone cromato liscio |

Caratteristiche

| | |
|----------|--------------|
| Calotta | piana liscia |
| Cono | liscio |
| Attacchi | Ø 1/2 F |



| CODICE | EURO/PZ | VERSIONE | PZ |
|--------|---------|----------|----|
| | | L cm | |
| 070620 | | 120 | 1 |
| 070621 | | 150 | 1 |
| 070622 | | 175 | 1 |
| 070623 | | 200 | 1 |

Maglia non estensibile



Caratteristiche

| | |
|----------|---------------------|
| Calotta | piana liscia |
| Cono | liscio antitorsione |
| Attacchi | Ø 1/2 F |



| CODICE | EURO/PZ | VERSIONE | PZ |
|--------|---------|----------|----|
| | | L cm | |
| 070627 | | 120 | 1 |
| 070625 | | 150 | 1 |
| 070628 | | 175 | 1 |
| 070626 | | 200 | 1 |

Caratteristiche

| | |
|---------|----------------------|
| Cono | Ø 1/2 F antitorsione |
| Attacco | girevole 15 x 1 M |

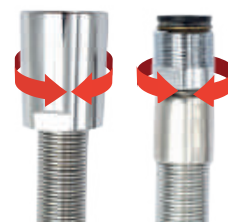

| CODICE | EURO/PZ | VERSIONE | PZ |
|--------|---------|----------|----|
| | | L cm | |
| 070630 | | 120 | 1 |
| 070631 | | 150 | 1 |
| 070632 | | 175 | 1 |
| 070633 | | 200 | 1 |

Caratteristiche

| | |
|----------|---------------------|
| Cono | liscio |
| Cono | liscio antitorsione |
| Attacchi | Ø 1/2 F |



| CODICE | EURO/PZ | VERSIONE | PZ |
|----------|---------|----------|----|
| | | L cm | |
| 070627CC | | 120 | 1 |
| 070625CC | | 150 | 1 |
| 070628CC | | 175 | 1 |
| 070626CC | | 200 | 1 |

Caratteristiche

| | |
|---------|-------------------|
| Cono | Ø 1/2 F liscio |
| Attacco | girevole 15 x 1 M |



| CODICE | EURO/PZ | VERSIONE | PZ |
|--------|---------|----------|----|
| | | L cm | |
| 070635 | | 120 | 1 |
| 070636 | | 150 | 1 |
| 070637 | | 175 | 1 |
| 070638 | | 200 | 1 |

FLESSIBILI DOCCIA
SIMPLE LINE
 Pratico, semplice, funzionale

ROUND PVC

Caratteristiche

| | |
|--------------------|----------------------|
| Materiale | PVC rinforzato |
| Sezione | circolare |
| Colore | argento |
| Finitura terminale | ottone cromato |
| Cono | Ø 1/2 F antitorsione |
| Attacco | Ø 1/2 F |

| CODICE | EURO/PZ | VERSIONE | PZ |
|--------|---------|----------|----|
| | | L cm | |
| 604300 | | 120 | 1 |
| 604301 | | 150 | 1 |
| 604302 | | 200 | 1 |



SQUARE PVC

Caratteristiche

| | |
|--------------------|----------------------|
| Materiale | PVC rinforzato |
| Sezione | quadrata |
| Colore | argento |
| Finitura terminale | ottone cromato |
| Cono | Ø 1/2 F antitorsione |
| Attacco | Ø 1/2 F |

| CODICE | EURO/PZ | VERSIONE | PZ |
|--------|---------|----------|----|
| | | L cm | |
| 604310 | | 120 | 1 |
| 604311 | | 150 | 1 |
| 604312 | | 200 | 1 |



STEEL

Caratteristiche

| | |
|--------------------|-----------------------------|
| Materiale | acciaio doppia aggraffatura |
| Colore | argento |
| Finitura terminale | ottone cromato |
| Cono | Ø 1/2 F antitorsione |
| Calotta | Ø 1/2 F |

| CODICE | EURO/PZ | VERSIONE | PZ |
|--------|---------|----------|----|
| | | L cm | |
| 604319 | | 120 | 1 |
| 604320 | | 150 | 1 |
| 604321 | | 200 | 1 |





SALISCENDI WHITE SUN



Composto da:

- Asta in acciaio inox
- Supporto in ABS
- Scorrevole in ABS
- Porta oggetti
- Doccetta white Ø 150 mm a 5 funzioni
- Finitura cromo lucido/bianco
- Flessibile Linea SIMPLE L 150 cm acciaio inox doppia aggaffatura

| CODICE | EURO/PZ | VERSIONE | PZ |
|--------|---------|------------------------|----|
| | | Dimensioni L x H mm | |
| 605100 | | 255 x 800 | 1 |

SALISCENDI BLACK SUN



Composto da:

- Asta in acciaio inox
- Supporto in ABS regolabile
- Scorrevole in ABS
- Doccetta white Ø 105 mm a 5 funzioni
- Finitura cromo lucido/nero
- Flessibile Linea SIMPLE L 150 cm acciaio inox doppia aggaffatura

| CODICE | EURO/PZ | VERSIONE | PZ |
|--------|---------|------------------------|----|
| | | Dimensioni L x H mm | |
| 605102 | | 160 x 735 | 1 |

**KIT DOCCIA
STEEL ROUND**

Composto da:

- Presa acqua a muro round in ottone cromato con supporto
- Braccio doccia round in ottone cromato Ø 22 x L 350 mm
- Soffione ultrapiatto round in acciaio inox AISI304
- Doccetta ispezionabile round in ottone cromato Ø 21 x L 196 mm
- Flessibile L. 150 cm (vedi pag. 38-39)

| CODICE | EURO/PZ | VERSIONE | | PZ |
|--------|---------|------------------|-------------|----|
| | | Soffione Ø mm | Flessibile | |
| 605201 | | 200 | Spring Line | 1 |
| 605203 | | 250 | | 1 |
| 605205 | | 300 | | 1 |
| 605200 | | 200 | Round PVC | 1 |
| 605202 | | 250 | | 1 |
| 605204 | | 300 | | 1 |

**KIT DOCCIA
STEEL SQUARE**

Composto da:

- Presa acqua a muro square in ottone cromato scomponibile con supporto
- Braccio doccia square in ottone cromato 250 x 250 x L 350 mm
- Soffione ultrapiatto square in acciaio inox AISI 304
- Doccetta square in ottone cromato L 35 x P 15 x H 230 mm
- Flessibile L 150 cm (vedi pag. 38-39)

| CODICE | EURO/PZ | VERSIONE | | PZ |
|--------|---------|------------------|-------------|----|
| | | Soffione □ mm | Flessibile | |
| 605207 | | 200x200 | Spring Line | 1 |
| 605209 | | 250x250 | | 1 |
| 605211 | | 300x300 | | 1 |
| 605206 | | 200x200 | Square PVC | 1 |
| 605208 | | 250x250 | | 1 |
| 605210 | | 300x300 | | 1 |



KIT DOCCIA
DUPLEX ROUND



Composto da:

- Presa acqua a muro con supporto round
- Flessibile L. 150 cm (vedi pag. 38-39)

Con doccetta in OTTONE ispezionabile

| CODICE | EURO/PZ | VERSIONE | | PZ |
|--------|---------|--------------|-------------------|----|
| | | Flessibile | Doccetta Round mm | |
| 605222 | | Simple Steel | Ø 21 x L 196 | 1 |
| 605223 | | Spring Line | | 1 |
| 605226 | | Simple Round | | 1 |

Con doccetta in ABS

| CODICE | EURO/PZ | VERSIONE | | PZ |
|--------|---------|--------------|-------------------|----|
| | | Flessibile | Doccetta Round mm | |
| 605232 | | Simple Steel | Ø 32 x L 200 | 1 |
| 605233 | | Spring Line | | 1 |
| 605234 | | Simple Round | | 1 |

KIT DOCCIA
DUPLEX ROUND
CON VALVOLA DI SICUREZZA



Composto da:

- Presa acqua a muro round in ottone cromato con supporto e valvola di sicurezza
- Flessibile L. 150 cm (vedi pag. 38-39)

Con doccetta in OTTONE

| CODICE | EURO/PZ | VERSIONE | | PZ |
|--------|---------|--------------|-------------------|----|
| | | Flessibile | Doccetta Round mm | |
| 605266 | | Simple Steel | Ø 21 x L 196 | 1 |
| 605267 | | Spring Line | | 1 |
| 605268 | | Simple Round | | 1 |

Con doccetta in ABS

| CODICE | EURO/PZ | VERSIONE | | PZ |
|--------|---------|--------------|-------------------|----|
| | | Flessibile | Doccetta Round mm | |
| 605260 | | Simple Steel | Ø 32 x L 200 | 1 |
| 605261 | | Spring Line | | 1 |
| 605262 | | Simple Round | | 1 |

KIT DOCCIA DUPLEX SQUARE

Composto da:

- Presa acqua a muro scomponibile in ottone comato con supporto square
- Flessibile L. 150 cm (vedi pag. 38-39)

Con doccetta in OTTONE

| CODICE | EURO/PZ | VERSIONE | | PZ |
|--------|---------|---------------|---------------------|----|
| | | Flessibile | Doccetta Square mm | |
| 605227 | | Simple Steel | L 35 x P 15 x L 196 | 1 |
| 605228 | | Spring Line | | 1 |
| 605231 | | Simple Square | | 1 |

Con doccetta in ABS

| CODICE | EURO/PZ | VERSIONE | | PZ |
|--------|---------|---------------|------------------------|----|
| | | Flessibile | Doccetta Square in ABS | |
| 605235 | | Simple Steel | L 35 x P 15 x L 196 | 1 |
| 605236 | | Spring Line | | 1 |
| 605237 | | Simple Square | | 1 |



KIT DOCCIA DUPLEX SQUARE CON VALVOLA DI SICUREZZA

Composto da:

- Presa acqua a muro scomponibile square in ottone cromato con supporto e valvola di sicurezza
- Flessibile L. 150 cm (vedi pag. 38-39)

Con doccetta in OTTONE

| CODICE | EURO/PZ | VERSIONE | | PZ |
|--------|---------|---------------|---------------------|----|
| | | Flessibile | Doccetta Square mm | |
| 605269 | | Simple Steel | L 35 x P 15 x L 200 | 1 |
| 605270 | | Spring Line | | 1 |
| 605271 | | Simple Square | | 1 |

Con doccetta in ABS

| CODICE | EURO/PZ | VERSIONE | | PZ |
|--------|---------|---------------|---------------------|----|
| | | Flessibile | Doccetta Square mm | |
| 605263 | | Simple Steel | L 35 x P 15 x L 200 | 1 |
| 605264 | | Spring Line | | 1 |
| 605265 | | Simple Square | | 1 |





KIT SHUT - OFF ROUND CLASSIC SALVASPAZIO

Doccetta shut-off con pulsante ON/OFF



Presca acqua a muro con attacco doccetta

Caratteristiche

| | |
|---------------|----------------------------------|
| Presca a muro | ottone cromato |
| Doccetta | ottone cromato - L 140 x Ø 50 mm |
| Flessibile | PVC grigio - 120 cm |



Flessibile Simple Line ROUND

| CODICE | EURO/PZ | PZ |
|--------|---------|----|
| 605244 | | 1 |

KIT SHUT - OFF SQUARE CLASSIC SALVASPAZIO

Doccetta shut-off con pulsante ON/OFF



Presca acqua a muro con attacco doccetta

Caratteristiche

| | |
|---------------|----------------------------------|
| Presca a muro | ottone cromato |
| Doccetta | ottone cromato - L 140 x Ø 50 mm |
| Flessibile | PVC grigio - 120 cm |



Flessibile Simple Line SQUARE

| CODICE | EURO/PZ | PZ |
|--------|---------|----|
| 605248 | | 1 |

KIT SHUT - OFF ROUND FAST PER RUBINETTO BIDET

Doccetta shut-off con pulsante ON/OFF



Caratteristiche

| | |
|-----------------------------|----------------------------------|
| Deviatore attacco rubinetto | ottone cromato M22 x 1 - M24 x 1 |
| Doccetta shut-off | ottone cromato L 140 x Ø 50 mm |
| Supporto doccetta a muro | ottone cromato |
| Attacco rubinetto | F22 x 1 |
| Flessibile | PVC grigio - 120 cm |



Deviatore di flusso per rubinetto

| CODICE | EURO/PZ | PZ |
|--------|---------|----|
| 605254 | | 1 |

KIT SHUT - OFF ROUND ELEGANT



Flessibile Simple Line
ROUND

| CODICE | EURO/PZ | PZ |
|--------|---------|----|
| 605251 | | 1 |

Caratteristiche

| | |
|-------------|----------------------------------|
| Pres a muro | ottone cromato |
| Doccetta | ottone cromato - L 140 x Ø 50 mm |
| Flessibile | PVC grigio - 120 cm |



KIT SHUT - OFF SQUARE ELEGANT



Flessibile Simple Line
SQUARE

| CODICE | EURO/PZ | PZ |
|--------|---------|----|
| 605253 | | 1 |

Caratteristiche

| | |
|-------------|----------------------------------|
| Pres a muro | ottone cromato |
| Doccetta | ottone cromato - L 140 x Ø 50 mm |
| Flessibile | PVC grigio - 120 cm |



KIT IDROSCOPINO ROUND ELEGANT



Flessibile Simple Line
ROUND

| CODICE | EURO/PZ | PZ |
|--------|---------|----|
| 605250 | | 1 |

Caratteristiche

| | |
|-------------|----------------------------------|
| Pres a muro | ottone cromato |
| Doccetta | ottone cromato - L 140 x Ø 50 mm |
| Flessibile | PVC grigio - 120 cm |

Doccetta idroscopino
con pulsante
a rilascio



KIT IDROSCOPINO SQUARE ELEGANT



Flessibile Simple Line
SQUARE

| CODICE | EURO/PZ | PZ |
|--------|---------|----|
| 605252 | | 1 |

Caratteristiche

| | |
|-------------|----------------------------------|
| Pres a muro | ottone cromato |
| Doccetta | ottone cromato - L 140 x Ø 50 mm |
| Flessibile | PVC grigio - 120 cm |

Doccetta
idroscopino con
pulsante a rilascio

Pres a acqua a
muro con attacco
idroscopino
e chiusura di
sicurezza





SOFFIONI DOCCIA
LOW ROUND
IN ACCIAIO INOX

Soffione utrapiatto round in acciaio inox
Ugelli in silicone anticalcare autopulenti

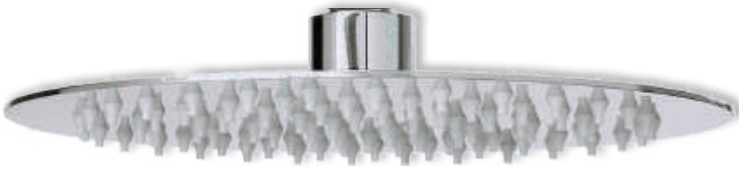

| Caratteristiche | |
|-----------------|-----------------------|
| Conforme | DM 174 |
| Materiale | acciaio inox AISI 304 |
| Spessore | 2 mm |
| Attacco | 1/2" F |
| Finitura | lucida |

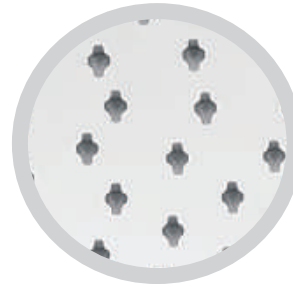

| CODICE | EURO/PZ | VERSIONE | | PZ |
|--------|---------|------------------|-----------|----|
| | | Soffione Ø mm | Ugelli n° | |
| 605400 | | 100 | 33 | 1 |
| 605401 | | 150 | 44 | 1 |
| 605402 | | 200 | 90 | 1 |
| 605403 | | 250 | 126 | 1 |
| 605404 | | 300 | 156 | 1 |

BRACCIO DOCCIA
ROUND

| Caratteristiche | |
|-----------------|-----------------------|
| Materiale | acciaio inox AISI 304 |
| Attacco | 1/2" M |
| Finitura | lucida |



PER INSTALLAZIONE A PARETE

| CODICE | EURO/PZ | VERSIONE | PZ |
|--------|---------|----------|----|
| | | Ø x L mm | |
| 605306 | | 22 x 300 | 1 |
| 605307 | | 22 x 350 | 1 |
| 605308 | | 22 x 400 | 1 |

PER INSTALLAZIONE A SOFFITTO

| CODICE | EURO/PZ | VERSIONE | PZ |
|--------|---------|----------|----|
| | | Ø x L mm | |
| 605300 | | 22 x 100 | 1 |
| 605301 | | 22 x 200 | 1 |
| 605302 | | 22 x 300 | 1 |

SOFFIONI DOCCIA
LOW SQUARE
IN ACCIAIO INOX

Soffione utrapiatto square in acciaio inox
Ugelli in silicone anticalcare autopulenti

Caratteristiche

| | |
|-----------|-----------------------|
| Conforme | DM 174 |
| Materiale | acciaio inox AISI 304 |
| Spessore | 2 mm |
| Attacco | 1/2" F |
| Finitura | lucida |

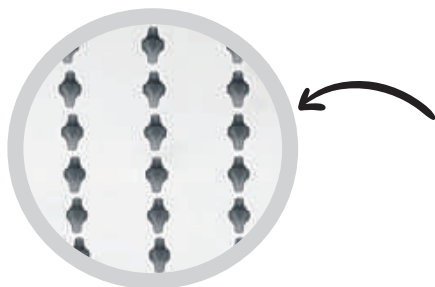
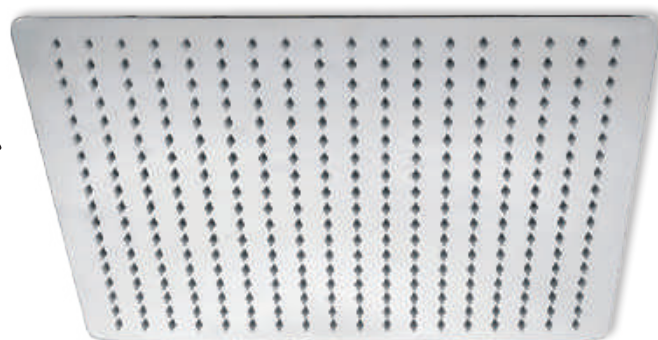
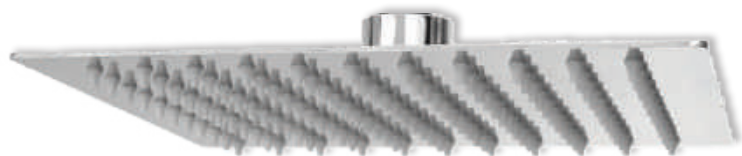

| CODICE | EURO/PZ | VERSIONE | | PZ |
|--------|---------|----------------------|-----------|----|
| | | Soffione L x L mm | Ugelli n° | |
| 605410 | | 100x 100 | 36 | 1 |
| 605411 | | 150x 150 | 64 | 1 |
| 605412 | | 200x 200 | 121 | 1 |
| 605414 | | 250x 250 | 196 | 1 |
| 605415 | | 300x 300 | 196 | 1 |
| 605413 | | 200 x 300 | 196 | 1 |

BRACCIO DOCCIA
SQUARE

Caratteristiche

| | |
|-----------|-----------------------|
| Materiale | acciaio inox AISI 304 |
| Attacco | 1/2" M |
| Finitura | lucida |

PER INSTALLAZIONE A PARETE

| CODICE | EURO/PZ | VERSIONE | PZ |
|--------|---------|----------|----|
| | | □ x L mm | |
| 605309 | | 25 x 300 | 1 |
| 605310 | | 25 x 350 | 1 |
| 605311 | | 25 x 400 | 1 |



PER INSTALLAZIONE A SOFFITTO

| CODICE | EURO/PZ | VERSIONE | PZ |
|--------|---------|----------|----|
| | | □ x L mm | |
| 605303 | | 25 x 100 | 1 |
| 605304 | | 25 x 200 | 1 |
| 605305 | | 25 x 300 | 1 |





**DOCGETTA ROUND
MONOGETTO IN ABS**



Caratteristiche

| | |
|------------|-----------------|
| Materiale | ABS anticalcare |
| Dimensioni | Ø 32 x L 200 mm |
| Attacco | 1/2" M |
| Finitura | cromo lucida |

| CODICE | EURO/PZ | PZ |
|--------|---------|----|
| 605518 | | 1 |

**DOCGETTA SQUARE
MONOGETTO IN ABS**



Caratteristiche

| | |
|------------|-----------------|
| Materiale | ABS anticalcare |
| Dimensioni | □ 25 x L 210 mm |
| Attacco | 1/2" M |
| Finitura | cromo lucida |

| CODICE | EURO/PZ | PZ |
|--------|---------|----|
| 605520 | | 1 |

**DOCGETTA ROUND
MONOGETTO CROMO**

Scomponibile ed
ispezionabile



Caratteristiche

| | |
|------------|-----------------|
| Materiale | ottone cromato |
| Dimensioni | Ø 21 x L 200 mm |
| Attacco | 1/2" M |
| Finitura | cromo lucida |

| CODICE | EURO/PZ | PZ |
|--------|---------|----|
| 605500 | | 1 |

**DOCGETTA SQUARE
MONOGETTO CROMO**



Caratteristiche

| | |
|------------|----------------------|
| Materiale | ottone cromato |
| Dimensioni | □ 35 x 15 x L 230 mm |
| Attacco | 1/2" M |
| Finitura | cromo lucida |

| CODICE | EURO/PZ | PZ |
|--------|---------|----|
| 605501 | | 1 |

**DOCGETTA LOW ROUND
MONOGETTO**



Caratteristiche

| | |
|------------|------------------|
| Materiale | ottone cromato |
| Dimensioni | Ø 100 x L 232 mm |
| Attacco | 1/2" M |
| Finitura | cromo lucida |
| Ugelli n° | 33 |

| CODICE | EURO/PZ | PZ |
|--------|---------|----|
| 605502 | | 1 |

**DOCGETTA LOW SQUARE
MONOGETTO**



Caratteristiche

| | |
|------------|---------------------|
| Materiale | ottone cromato |
| Dimensioni | □ 10 x 8 x L 232 mm |
| Attacco | 1/2" M |
| Finitura | cromo lucida |
| Ugelli n° | 30 |

| CODICE | EURO/PZ | PZ |
|--------|---------|----|
| 605503 | | 1 |

DOCCETTA 5 GETTI



Caratteristiche

Materiale ABS anticalcare
 Dimensioni Ø 120 mm
 Attacco 1/2" M
 Finitura cromo lucida

| CODICE | EURO/PZ | PZ |
|--------|---------|----|
| 605516 | | 1 |

DOCCETTA MONOGETTO



Caratteristiche

Materiale ABS anticalcare
 Dimensioni Ø 70 mm
 Attacco 1/2" M
 Finitura cromo lucida

| CODICE | EURO/PZ | PZ |
|--------|---------|----|
| 605521 | | 1 |

DOCCETTA 3 GETTI



Caratteristiche

Materiale ABS anticalcare
 Dimensioni Ø 120 mm
 Attacco 1/2" M
 Finitura nero/cromo

| CODICE | EURO/PZ | PZ |
|--------|---------|----|
| 605515 | | 1 |

DOCCETTA MONOGETTO



Caratteristiche

Materiale ABS anticalcare
 Dimensioni □ 35 x 15 x L 230 mm
 Attacco 1/2" M
 Finitura cromo lucida

| CODICE | EURO/PZ | PZ |
|--------|---------|----|
| 605519 | | 1 |

DOCCETTA SHUT-OFF

Con pulsante ON / OFF



ROUND

| CODICE | EURO/PZ | VERSIONE | PZ |
|--------|---------|----------------------------|----|
| | | Dimensioni Ø x H x L mm | |
| 605504 | | 20 x 55 x 120 | 1 |

Con pulsante di azionamento



SQUARE

| CODICE | EURO/PZ | VERSIONE | PZ |
|--------|---------|------------------------|----|
| | | Dimensioni □ x L mm | |
| 605505 | | 30 x 30 x 140 | 1 |

IDROSCOPINO
 Con pulsante di azionamento



ROUND

| CODICE | EURO/PZ | VERSIONE | PZ |
|--------|---------|----------------------------|----|
| | | Dimensioni Ø x H x L mm | |
| 605510 | | 20 x 55 x 120 | 1 |



SQUARE

| CODICE | EURO/PZ | VERSIONE | PZ |
|--------|---------|------------------------|----|
| | | Dimensioni □ x L mm | |
| 605511 | | 30 x 30 x 140 | 1 |



**SUPPORTO A MURO
PER DOCCETTA**



Caratteristiche

Materiale ottone cromato
Finitura cromo lucida

| CODICE | EURO/PZ | VERSIONE | | | PZ |
|--------|---------|--------------------------|----------|--------------------|----|
| | | <input type="checkbox"/> | Modello | Dimensioni mm | |
| 605610 | | <input type="checkbox"/> | A Round | Ø 28 x H 40 | 1 |
| 605611 | | <input type="checkbox"/> | B Square | □ 31 x H 20 x L 40 | 1 |

DEVIATORI DI FLUSSO

**DEVIATORE DI FLUSSO
PER BRACCIO DOCCIA ROUND**



Permette di inserire una doccetta al braccio doccia senza opere murarie

Caratteristiche

Materiale ottone cromato
Dimensioni Ø 40 x L 62 mm
Attacco E-U 1/2"
Finitura cromo lucida

| CODICE | EURO/PZ | PZ |
|--------|---------|----|
| 605600 | | 1 |

**DEVIATORE SQUARE
UNIVERSALE**



Caratteristiche

Materiale ottone cromato
Dimensioni □ 40 x L 62 mm
Attacco E-U 1/2"
Finitura cromo lucida

| CODICE | EURO/PZ | PZ |
|--------|---------|----|
| 605612 | | 1 |

**DEVIATORE DI FLUSSO
PER RUBINETTO**



Permette di inserire un idroscopino al rubinetto del bidet senza opere murarie.

Caratteristiche

Materiale ottone cromato
Dimensioni Ø 25 x H 56 x L 60 mm
Attacco E-U 1/2" M - M22x1 - M24x1
Finitura cromo lucida

| CODICE | EURO/PZ | PZ |
|--------|---------|----|
| 605601 | | 1 |

PRESE ACQUA A MURO

**PRESA ACQUA A MURO
PER FLESSIBILE**

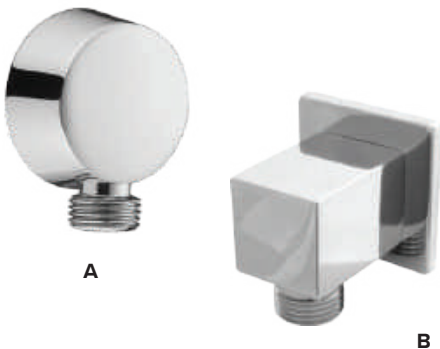

Caratteristiche

Materiale ottone cromato
Attacco E-U 1/2" MM
Finitura cromo lucida

| CODICE | EURO/PZ | VERSIONE | | | PZ |
|--------|---------|--------------------------|----------|---------------|----|
| | | <input type="checkbox"/> | Modello | Dimensioni mm | |
| 605602 | | <input type="checkbox"/> | A Round | Ø 50 x H 24 | 1 |
| 605603 | | <input type="checkbox"/> | B Square | □ 25 x L 40 | 1 |

**PRESA ACQUA A MURO ROUND
CON PORTA DOCCETTA**



Caratteristiche

Materiale ottone cromato
Dimensioni Ø 32 x H 600 mm
Attacco E-U 1/2" MM
Finitura cromo lucida

| CODICE | EURO/PZ | PZ |
|--------|---------|----|
| 605604 | | 1 |

**PRESA ACQUA A MURO SQUARE
CON PORTA DOCCETTA
SCOMPONIBILE**

Caratteristiche

Materiale | ottone cromato
Dimensioni | □ 30 x L 650 mm
Attacco E-U | 1/2"MM
Finitura | cromo lucida

| CODICE | EURO/PZ | PZ |
|--------|---------|----|
| 605605 | | 1 |



**PRESA ACQUA A MURO CON PORTA DOCCETTA
E VALVOLA DI SICUREZZA**

Caratteristiche

Materiale | ottone cromato
Attacco E-U | 1/2"MM
Finitura | cromo lucida

| CODICE | EURO/PZ | VERSIONE | | | PZ |
|--------|---------|----------|---------|---------------|----|
| | | □ | Modello | Dimensioni mm | |
| 605606 | | A | Round | ∅ 30 x L 68 | 1 |
| 605607 | | B | Square | □ 30 x L 68 | 1 |



A



B

SIFONI

**SIFONE ARREDO ALTO
SQUARE**

Caratteristiche

Attacco | 1"1/4
Finitura | ottone cromato

| CODICE | EURO/PZ | PZ |
|--------|---------|----|
| 603902 | | 1 |



**SIFONE ARREDO BASSO
ROUND**

Caratteristiche

Attacco | 1"1/4
Finitura | ottone cromato

| CODICE | EURO/PZ | PZ |
|--------|---------|----|
| 603901 | | 1 |



**SIFONE ARREDO ALTO
ROUND**

Caratteristiche

Attacco | 1"1/4
Finitura | ottone cromato

| CODICE | EURO/PZ | PZ |
|--------|---------|----|
| 603900 | | 1 |



**FLESSIBILE ESTENSIBILE
IN ACCIAIO INOX AISI 304**

Caratteristiche

Attacco | 1"1/4
Finitura | acciaio inox

| CODICE | EURO/PZ | PZ |
|--------|---------|----|
| 060679 | | 1 |





RUBINETTI PER LAVATRICI



RUBINETTO DIRITTO PER LAVATRICE

Maniglia in ottone

Caratteristiche

Attacco 1/2" x 3/4"
Finitura cromata

| CODICE | EURO/PZ | PZ |
|--------|---------|----|
| 607025 | | 1 |



RUBINETTO A SFERA PER LAVATRICE

Con maniglia in ABS

Caratteristiche

Attacco 1/2" x 3/4"
Finitura cromata

| CODICE | EURO/PZ | PZ |
|--------|---------|----|
| 607026 | | 1 |



A



B

RUBINETTO A SFERA LUSO PER LAVATRICE

Caratteristiche

Attacco 1/2" x 3/4"
Finitura cromata

| CODICE | EURO/PZ | VERSIONE | | PZ |
|--------|---------|--------------------------|----------|----|
| | | <input type="checkbox"/> | Maniglia | |
| 607027 | | A | ABS | 1 |
| 607028 | | B | Metallo | 1 |



RUBINETTO A SQUADRA PER LAVATRICE

Chiusura a vitone

Caratteristiche

Attacco 1/2" x 3/4"
Finitura cromata

| CODICE | EURO/PZ | PZ |
|--------|---------|----|
| 607031 | | 1 |



RUBINETTO SALVASPAZIO DOPPIO ATTACCO LAVATRICE

Maniglia in ottone

Caratteristiche

Attacco 1/2" x 3/4"
Finitura cromata

| CODICE | EURO/PZ | PZ |
|--------|---------|----|
| 607029 | | 1 |



RUBINETTO SALVASPAZIO ATTACCO LAVATRICE

Maniglia in ottone

Caratteristiche

Attacco 1/2" x 3/4"
Finitura cromata

| CODICE | EURO/PZ | PZ |
|--------|---------|----|
| 607030 | | 1 |



RUBINETTO BI-USO ATTACCO LAVATRICE

Caratteristiche

Attacco 1/2" x 3/4"
Finitura cromata

| CODICE | EURO/PZ | PZ |
|--------|---------|----|
| 607032 | | 1 |

RUBINETTI CASSETTE WC

RUBINETTO PER CASSETTA WC

Con maschio girevole ed estraibile
Con vite di sblocco per estrazione curvetta

Caratteristiche

Attacco 1/2" x 10 mm
Finitura cromata

| CODICE | EURO/PZ | PZ |
|--------|---------|----|
| 607035 | | 1 |

RUBINETTO PER CASSETTA WC CON TUBETTO



Caratteristiche

Attacco 1/2" M x 3/8"
Finitura cromata

| CODICE | EURO/PZ | PZ |
|--------|---------|----|
| 607036 | | 1 |

CANNUCCE

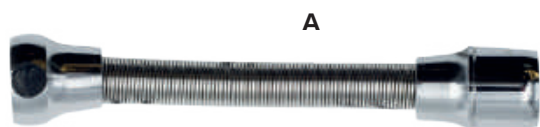
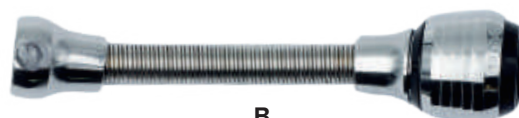
CANNUCCE

A

B

Aeratore in ottone
cromato monogetto

Maglia in acciaio
inox AISI 304



Aeratore in ABS
a doppio getto

Caratteristiche

Finitura cannuccia acciaio inox AISI 304 cromo
Finitura terminali ottone cromato
Aeratore Ø 22 x 1 F
Lunghezza 150 mm

| CODICE | EURO/PZ | | VERSIONE | | PZ |
|--------|---------|---|---------------|----------------|----|
| | | | Getto | Aeratore | |
| 070655 | | A | Singolo | Ottone cromato | 1 |
| 070660 | | B | Doppio | ABS | 1 |
| 070697 | | C | M 24x1 M 22x1 | | 1 |

C

Riduzione
M 24x1 M 22x1



RUBINETTI SOTTOLAVABO



RUBINETTO SOTTOLAVABO CON FILTRO E SNODO

Funzionamento a vitone e calotta alta

Caratteristiche

Attacco 1/2" x 3/8" x 10 mm
Finitura cromata

| CODICE | EURO/PZ | PZ |
|--------|---------|----|
| 607023 | | 1 |



RUBINETTO A SFERA SOTTOLAVABO

Con filtro e calotta alta

Caratteristiche

Attacco 1/2" x 10 mm
Finitura cromata

| CODICE | EURO/PZ | PZ |
|--------|---------|----|
| 607020 | | 1 |



RUBINETTO A SFERA SOTTOLAVABO

Con filtro e snodo calotta alta

Caratteristiche

Attacco 1/2" x 10 mm
Finitura cromata

| CODICE | EURO/PZ | PZ |
|--------|---------|----|
| 607021 | | 1 |



RUBINETTO SOTTOLAVABO CON FILTRO

Funzionamento a vitone e calotta alta

Caratteristiche

Attacco 1/2" x 3/8" x 10mm
Finitura cromata

| CODICE | EURO/PZ | PZ |
|--------|---------|----|
| 607022 | | 1 |

CURVETTE SOTTOLAVABO



CURVETTA STAMPATA SOTTOLAVABO

Caratteristiche

Attacco 1/2" x 10 mm
Finitura cromata

| CODICE | EURO/PZ | PZ |
|--------|---------|----|
| 607010 | | 1 |



A



B

CURVETTA SOTTOLAVABO

Con maschio girevole ed estraibile
Con vite di sblocco per estrazione curvetta

Caratteristiche

Attacco 1/2" x 3/8" x 10 mm
Finitura cromata

| CODICE | EURO/PZ | VERSIONE | PZ |
|--------|---------|---|----|
| | | <input type="checkbox"/> Modello | |
| 607011 | | A 45° | 1 |
| 607012 | | B 90° | 1 |

PILETTE CLICK CLACK



ROUND CROMATA

Caratteristiche

| | |
|----------|---------|
| Attacco | 1" 1/4 |
| Altezza | H 35 mm |
| Finitura | Cromata |

| CODICE | EURO/PZ | PZ |
|--------|---------|----|
| 606154 | | 1 |



ROUND BASSA CROMATA

Caratteristiche

| | |
|----------|---------|
| Attacco | 1" 1/4 |
| Altezza | H 25 mm |
| Finitura | Cromata |

| CODICE | EURO/PZ | PZ |
|--------|---------|----|
| 606153 | | 1 |



SQUARE UNIVERSALE CROMATA

Caratteristiche

| | |
|----------|---------|
| Attacco | 1" 1/4 |
| Altezza | H 35 mm |
| Finitura | Cromata |

| CODICE | EURO/PZ | PZ |
|--------|---------|----|
| 606155 | | 1 |



BASSA CROMATA CON TROPPO PIENO

Caratteristiche

| | |
|----------|---------|
| Attacco | 1" 1/4 |
| Altezza | H 35 mm |
| Finitura | Cromata |

| CODICE | EURO/PZ | VERSIONE | | PZ |
|--------|---------|--------------------------|---------|----|
| | | <input type="checkbox"/> | Modello | |
| 606156 | | A | Round | 1 |
| 606157 | | B | Square | 1 |



ALTA CROMATA CON TROPPO PIENO

Caratteristiche

| | |
|----------|---------|
| Attacco | 1" 1/4 |
| Altezza | H 35 mm |
| Finitura | Cromata |

| CODICE | EURO/PZ | VERSIONE | | PZ |
|--------|---------|--------------------------|---------|----|
| | | <input type="checkbox"/> | Modello | |
| 606158 | | A | Round | 1 |
| 606159 | | B | Square | 1 |



| Indice in ordine alfabetico | pagine |
|--|--------|
| BOX DOCCIA | |
| LINEA LOFTY | 2-11 |
| LINEA ACRIL | 14-17 |
| Raccordo per due pareti doccia Walk - in | 11 |
| Accessori e ricambi per box doccia Linea Lofty | 12 |
| BRACCIO DOCCIA | |
| <i>Round - Square</i> | 46-47 |
| COMPLEMENTI BAGNO - ACCESSORI | |
| <i>Sifoni</i> | 51 |
| <i>Rubinetti per lavatrici</i> | 52 |
| <i>Rubinetti per cassette WC</i> | 53 |
| <i>Cannucce</i> | 53 |
| <i>Rubinetti sottolavabo</i> | 54 |
| <i>Curvette sottolavabo</i> | 54 |
| <i>Pilette click clack</i> | 55 |
| COMPLEMENTI DOCCIA - ACCESSORI | |
| <i>Supporto a muro per doccetta</i> | 50 |
| <i>Deviatori di flusso</i> | 50 |
| DOCCETTE | |
| <i>Monogetto e plurigetto</i> | 48-49 |
| <i>Shut - off</i> | 49 |
| <i>Idroscopino</i> | 49 |
| FLESSIBILI DOCCIA | |
| SPRING LINE | 38 |
| SIMPLE LINE <i>Round PVC - Square PVC - Steel</i> | 39 |
| KIT DOCCIA | |
| <i>Steel Round - Steel Square</i> | 41 |
| <i>Duplex Round</i> | 42 |
| <i>Duplex Square</i> | 43 |

| Indice in ordine alfabetico | pagine |
|--|---------|
| KIT IDROSCOPINO | |
| <i>Round Elegant - Square Elegant</i> | 45 |
| KIT SHUT - OFF | |
| <i>Round Classic - Square Classic - Round Fast</i> | 44 |
| <i>Round Elegant - Square Elegant</i> | 45 |
| PIATTI DOCCIA | |
| PIATTI DOCCIA ZERO in Mineral Plane | 18 - 23 |
| Accessori e ricambi per piatti doccia ZERO | 23 |
| SALISCENDI | |
| <i>White Sun - Black Sun</i> | 40 |
| SALISCENDI | |
| <i>White Sun - Black Sun</i> | 40 |
| SISTEMA DI SCARICO A PAVIMENTO PER DOCCIA | |
| INOX STYLE | 24-25 |
| <i>Linea Luxury rettangolare</i> | 26-27 |
| <i>Linea Luxury quadrata</i> | 30 |
| <i>Linea Ram Rettangolare</i> | 28-29 |
| <i>Linea Ram triangolare</i> | 31 |
| <i>Chiusino sifonato quadrato</i> | 32 |
| INOX SLOT | 33 |
| <i>Linea Floor</i> | 34 |
| <i>Linea Wall</i> | 35 |
| <i>Linea Floor 2DS</i> | 36-37 |
| SOFFIONI DOCCIA | |
| <i>Low Round - Low Square</i> | 46-47 |



**Per le nostre condizioni di vendita
inquadra il QR code**



SEDE: via 1° Maggio, 7 - 21012 Cassano Magnago (VA) Tel: 0331 - 20.49.11 r.a. - Fax: 0331 - 20.14.58
E-mail: ferrarivarese@ferrariwelcome.it

FILIALE: via S. Pieretto, 50 - 55060 Capannori (LU) Tel: 0583 - 941.41 r.a. - Fax: 0583 - 946.82
E-mail: ferrarilucca@ferrariwelcome.it

FILIALE: viale dell'Artigianato, 276 - 35047 Solesino (PD) Tel: 0429 - 76.72.27 - Fax: 0429 - 70.18.10
E-mail: ferraripadova@ferrariwelcome.it

SCARICA LA NOSTRA APP



APP ANDROID



APP IOS

SEGUICI SUI NOSTRI
CANALI SOCIAL



FACEBOOK



INSTAGRAM



YOUTUBE

Edizione aprile 2023

